

CARTEK[®]

AUTOPARTES

CATÁLOGO DE

TOMAS DE AGUA

/ Water Outlet



CATÁLOGO DE TOMAS DE AGUA / 2014-2015

CALIDAD DE EQUIPO ORIGINAL



www.carttek.com.mx



TOMAS DE AGUA Water Outlet



2

9136



ACURA

Americana

Acura 86/90 (Todos) Maq. 258 4.2L
No.Original: 3235347 Ref: 5347/8178

5022



CHRYSLER

Americana

Chrysler todos Maq 156 2.6L 82/89, Caravan,
Mini Ram 2.6L 83/87 Dodge Ram 50, Power
Ram 50, D 50 Pick-up 2.0 y 2.6L 83/86
Plymouth 76/87 No.Original: MD 020634
Ref: 9171

5023



CHRYSLER

Nacional y Americana

Chrysler, V-8 Motor 360 Dodge, Plymouth 6 Cil.
70/Up; Camioneta V-6 92/Up
No. Original: 2121524, 2121908 Ref: 524

5063



CHRYSLER

Nacional

Chrysler V8 318 y 360
Americana
Chrysler, Dodge, Plymouth V8 Cil Maq 383, 318 67/78
Camionetas Maq. 318,360, 400 y 440 74/78
Dodge 61/78 No. Original: 3698565, 3751958, 2780970
Ref:4013

5083



CHRYSLER

Americana

Chrysler, Dodge y Plymouth todos con A/C
8 Cil Maq. 318, 59/67 No. Original 1855605

5096



CHRYSLER

Americana

Chrysler todos, Maq. 383 A/C '71 8 Cil., Chrysler,
Dodge y Plymouth Maq. 400 y 440 '72 D-600
No. Original: 3614013, 3614012

5153



CHRYSLER

Nacional

Chrysler V-8 Maq. 318 y 360 5.2 y 5.9L y
Lebaron 70/Up 5.2 y 5.9L y Lebaron 70/Up
Americana
All Dodge L.D. Truck 239 3.9
No. Original: 4100490 Ref.: 490

5169



CHRYSLER

Nacional y Americana

Chrysler 4 Cil. Maq 135 2.2 y 2.5L Serie "K" y "E" ;Shadow,
Spirit, Phantom 82/Up, Dakota 86/90; Caravan, Mini Ram
83/90; Buick 82/83; Lebaron 82/89; Town & Country 82/88
Ney Yorker 83/87; Aries 81/87
Lancer 85/89
No. Original: 5214514 Ref: 4514

5172



CHRYSLER

Americana

Chrysler, Dodge (Except Stealth), Plymouth
V-6 3.0L 87/94 No. Original: MD097041

5173



CHRYSLER

Americana

Chrysler Town & Contry 3.3 y 3.8L 90/92, Dodge
Dynasty 3.3L 90/93, Dodge Caravan, Mini Ram 3.3L y
Plymouth Voyager 90/92 No. Original: 5281188

5174



CHRYSLER

Americana

Shadow, Spirit, Lebaron 2.5L 91/94, Caravan,
Voyager 3.3L Town & Contry todas 93/94
No. Original: 5281063

5175



CHRYSLER

Nacional y Americana

B150, 1500, 250, 2500, 350 Van, D 150, 250,
350 Pick-Up, Dakota Durango, Jeep Grand
Cherokee, Ram 1500 2500, 3500, 3.9, 5.2 y
5.9L, 94/00; Dodge 92/03 No. Original: 53020115

5176



CHRYSLER

Nacional y Americana

Grand Voyager, Town & Contry, Caravan, Grand
Caravan V-6 3.3 y 3.8L 99/00 Voyager 2000; Chrysler 90/00;
Dodge y Plymouth 96/00 No. Original: 4621162AC

5177



CHRYSLER

Americana

Nacional y Americana Dodge Dakota 4 Cil 2.5L
97/00, Jeep Cherokee, Wrangler 4 y 6 Cil 2.5 y
4.0L 91/00 Grand Cherokee 6 Cil
4.0L 93/00 No. Original: 53006192

5178



CHRYSLER

Nacional

Nacional y Americana Dodge R 2500, 3500
Pick-up 94/98 Dodge Ram 2500, 3500
Pick-up 5.9L 94/99 No. Original: 04761293

5179



CHRYSLER

Nacional y Americana

Dodge Ram 2500, 3500 Pick-up 5.9L 00/Up
No. Original: 05015713AA

5180



CHRYSLER
Nacional
Cirrus 2000 2.0L 4 Cil. 94/00 (un árbol)
Americana
Cirrus sohc 4 Cil. 2.0L 00 Neon sohc 95/99; Stratus sohc 95/00; Breeze sohc 96/00; Dodge y Plymouth 95/00 No. Original: 4546729

5181



CHRYSLER
Nacional
Neon 2000 2.0L 4Cil 00/06
Americana
Neon 4 Cil. 2.0L 00/01, ACR Y ES 02, R/T 01/04, SE 02/05, SXT 00 Chrysler 00; Dodge 00/05; Plymouth 00/01 No. Original: 5278156AA

5182



CHRYSLER
Nacional
Stratus 2.4L 4 Cil. 95/06
Americana
Cirrus 96/00, Sebring 96/06
Stratus 95/06, Breeze 98/00
4Cil 2.0L No. Original: 04663501AA

5183



CHRYSLER
Nacional y Americana
Chrysler Neon 2.0L 4 Cil.
DHOC (dos árboles) 95/99
No. Original: 4495717

5184



CHRYSLER
Nacional y Americana
Chrysler Stratus Turbo 2.4L 4Cil. 96/02
No. Original: 04849098AC

5185



CHRYSLER
Nacional
Neon 2.0L 4 Cil. 03/05 Stratus 2.0L 4 Cil. 02/06
Americana
Neon 2.0L 4 Cil. 03/05 Stratus 2.0L 4 Cil. 05/06
No. Original: 04777171AB

5186



CHRYSLER
Nacional
PT Cruiser 2.4L 4 Cil. 00/09
Americana
PT Cruiser 01/07 PT Cruiser Limited, PT Cruiser Street Cruiser, PT Cruiser Touring 2006 4 Cil. 2.4L No. Original: 05278203AB

5187



CHRYSLER
Nacional
Intrepid 2.7L 6 Cil. 96/01
Americana
Intrepid, Intrepid ES 98/01 Intrepid SE 02/04 Concorde 98/01 Concorde LX 02/04 6 Cil. 2.7L No. Original: 04792328

5188



CHRYSLER
Nacional
Cirrus V6 2.7L 01/06
Americana
Sebring V6 2.7L 01/06 No. Original: 04792630AA

5189



CHRYSLER
Nacional
Charger, Concorde, Cirrus, Stratus 2.7L, 300 LE, LX, L2 6 Cil. 06/10
Americana
Concorde V6 2.7L 98/02
No. Original: 5017183AB

5190



CHRYSLER
Nacional
Ram Van, Pick Up, Dakota, Cherokee, Durango 3.9L 8 Cil. 00/03
Americana
Dakota V6 3.9L 00/03 Durango 00/04
No. Original: 52029195AK

5191



CHRYSLER
Nacional y Americana
Chrysler Intrepid 6 Cil 3.2L 98/00
No. Original: 04792361

5192



CHRYSLER
Nacional y Americana
Chrysler V6 2.5L
Sebring JX y JXI 96/00, LX y LXI 95/00, Avenger 97/00, Avenger coupe 95/98, Ddge V6 2.5L
No. Original: 191144830

5193



CHRYSLER
Nacional
Jeep Wrangler 2.4L 4 Cil 01/08
Americana
Voyager y Caravan 01/03, SE 04/07, Liberty 02/05 Wrangler 03/06 2.4L 4 Cil
No. Original: 4781489AA

5194



CHRYSLER
Nacional
Voyager 91-00 6 Cil. 3.0L
Americana
Voyager '00, Dodge Caravan 96-00, Grand Caravan 96-97, Plymouth Grand Voyager 96-97, Plymouth Voyager 96-00 6 Cil 3.0L
No. Original: 4625656

5195



CHRYSLER
Nacional
RAM, Durango, Nitro, Liberty, Cherokee 99-12 6 & 8 Cil. 3.7 & 4.7L
Americana
Dodge Dakota, Durango 00-07 8 Cil. 4.7L, Dodge Dakota, Durango 04-05 6 Cil. 3.7L, Dodge RAM 1500 Pick Up 02-07 6 Cil. 3.7L, Dodge RAM 1500 Pick up 02-07 8 Cil. 4.7L, Jeep Grand Cherokee Laredo, Limited 00-07 8 Cil. 4.7L, Jeep Grand Cherokee Overland 02-04 8 Cil. 4.7L, Jeep Liberty Limited, Renegade, Sport 03-05 6 Cil. 3.7L, Chrysler Aspen Limited 07 8 Cil. 4.7L, Jeep Commander 06-07 8 Cil. 4.7L, Mitsubishi Raider 06-07 6 Cil. 3.7L No. Original: 53020887AD

TOMAS DE AGUA Water Outlet



4

5196



CHRYSLER

Nacional
Avenger 06-13 y Compass Patriot 06-1 4 Cil. 2.0L
Journey 06-13 4 Cil. 2.4L Caliber 06-13 4 Cil. 1.8L
Americana
Chrysler Sebring, Jeep Compas y Patriot '07
4 Cil 2.4L
No. Original: 4884571AB

5197



CHRYSLER

Nacional
Magnum, 300, Charger 04-10 6 Cil. 2.7L
Americana
Chrysler 300, Dodge Charge y Magnum '07
6 Cil. 2.7L
No. Original: 4792916AE

5198



CHRYSLER

Nacional
300C 06-10 6 Cil. 2.7L
Magnum, 300, Charger
00-10 6 Cil. 2.7L

7008



FORD

Nacional y Americana
Alojamiento para bomba de
agua Ford 4 Cil. Motor 140
2.3L Topaz de 1984/Up
No. Original: E53E-8508AA
Ref.: 8508

7009



FORD

Americana
Ford Courier Pick-up 110 &
122 72/80, 4 Cil. (1.8 Lts)
No. Original: D27Z-8592B
Ref.: 9198

7010



FORD

Americana
All Ford & Mercury 49/53
F1, F6, F100, F600 49/53
All Crown '71
No. Original: 1BA-8592A
16331-40010

7026



FORD

Sin entrada de válvula
difusora de temperatura
Nacional
Ford V8 F100, 150, 200, 250, 350 Y 600
Americana
Ford todos Maq 289 60/61,
Bronco Maq 305, 335, 351 65/69
No. Original: C5AZ-8592E Ref.: 1592-B

7047



FORD

Americana
Ford B-F-N 100/700 272
56/58 & P 350/500 292 V8
58/64; All Ford Truck 239 &
256 6 Cil. 54/55
No. Original: B5C-8592A

7050



FORD

Americana
Ford todos Maq. 352, 390
410 V-8 65/67, Mercury
Maq 427 y 428
No. Original: C5AZ-8592B

7051



FORD

Americana
Ford Series E y F 100/350 Econoline Van y Pick-up
Maq 300 73/78 Excepto California, Serie P 350/500
Step Van y Parcel Delivery Maq 300 73/76;
No. Original: C8AZ-8592B
C5AZ-8592A, C5AZ-8592D

7064



FORD

Americana
Ford Camionetas todas Maq
330, 361 y 391 66/74
Ford Camionetas todas Maq
351 64/67
No. Original: C4TZ-8592B

7072



FORD

Nacional
Ford 200, Falcon 60/72 Bronco 6 Cil 144, 200, 60/72
Americana
Ford Todos L-6 Maq 144, 170 y 200 60/87 2.8 y 3.3L
66/74; Mercury 60/83
No. Original: C1DZ-8592B,
C8DZ-8592A, C1DZ-8592C

7073



FORD

Americana
Ford y Mercury Todos
Maq 289 60/61
Ford Bronco Todos
Maq 302 65/69
Lincoln 77/90; Mercury 63/91
No. Original: C5AZ-8592E

7074



FORD

Americana
Ford Todos Maq 390,
410, 427, 428, 428CJ V-8
66/73, Ford F 100, 350 V-8
Maq 360, 390 73/76 Mercury 67/70
No. Original: C7AZ-8592A
C4TZ-8592C

7079



FORD











Con entrada de válvula difusora de temperatura
Nacional y Americano
Ford todos V8 Maq 289, 302 y 351 W 68/91 V-8, Crown Victoria,
Custom 5.8L Galaxie y LTD 86/91, Lincoln Town Car 302 y
351 5.0L 86/91 F-100, F-150, F-250, F-350 Y F-600
No. Original: C9QZ-8592B C3OZ-8592A
Ref.: 1592

7080



FORD

Nacional
Falcon 68/84, F 100 6 Cil 250
Americana
Ford y Mercury todos L-6
250 4.1L sin A/C 68/84
No. Original: C9DZ-8592B
C8DZ-8592B, C9DZ-8592A

<p>7081</p>  <p>FORD Nacional Falcon 68/84, F 100 6 Cil 250 Americana Ford y Mercury todos L-6 250 4.1L con A/C 68/84 No. Original: C9DZ-8592A</p>	<p>7089</p>  <p>FORD Americana Ford V-8 Maq 302,335, 351 62/92 F100, 150, 250, 350 600 No. Original: C9OZ-8592A 74ZY-8592AA</p>	<p>7091</p>  <p>FORD Americana Ford Series E-F 100/350 Econoline, Van y Pick-up 75/76, Ford y Mercury Todos Maq 351 y 400 5.8, 6.6 y 7.5L No. Original: D1AZ-8592A y D0AZ-8592A</p>	<p>7102</p>  <p>FORD Americana Ford Series E-F 100/350 Econoline, Van y Pick-up 75/79, Ford y Mercury Todos Maq 351C, 351M 400 V-8 5, 6.6, y 7.5L 74/76 No. Original: D5AZ-8592A D4AZ-8592A</p>
<p>7107</p>  <p>FORD Americana Ford y Mercury todos frente bajo V-6 Maq 171 2.8L 74/79 No. Original: D4ZZ-8592C</p>	<p>7112</p>  <p>FORD Americana Ford V-6 Maq. 171 2.8L 74/76 Ford y Mercury todos 71/79 No. Original: D5FZ-8592A D6FZ-8592A</p>	<p>7113</p>  <p>FORD Americana All Ford (2800cc) Engine, Lower Front; All Mercury (2.8L) (2800cc) Engine, Lower Front 74/79; All Mercury (2600cc) Engine, Lower Rear '73 2.8L V6 No. Original: D2RY-8592C</p>	<p>7117</p>  <p>FORD Americana Topaz Tempo Pinto sin aire acondicionado Ranger, Courier 140 2.3L 74/82, Ford y Mercury todos 4 Cil 74/78 No. Original: D4FZ-8592A</p>
<p>7118</p>  <p>FORD Nacional Thunderbird, Cougar 90/94 Microbus TBI 92/02 V-8 302, 351 Americana Ford E 100/350 Econoline Van 351 y 400 75/79 Mustang 4.2 y 5.8L 74/89; Explorer y Lobo; F100 Pck up 81/83; Lincoln Continental & Mark VII 86/91 Ford 74/01; Lincoln 86/92; Mercury 80/01 No. Original: D5TZ-8592A F0ZZ-8592A</p>	<p>7123</p>  <p>FORD Nacional Marquiz, Crown Victoria LTD 351, 400, Bronco 351M y 400 77/79 Cañon Corto 5.8 y 6.6L Americana All Ford, F 100/350 Pickup Lincoln & Mercury 77/79 All Ford Bronco 8 Cylinder 78/79 No. Original: D7AZ-8592A</p>	<p>7124</p>  <p>FORD Americana Ford y Mercury todos V-6 Maq 171 2.8L 77/79 No. Original: D6RY-8592A D6FZ-8592A</p>	<p>7125</p>  <p>FORD Americana Ford 429 Lincoln, Mercury 68/79 Econoline 429 y 460 V-8 7.5L 73/74 No. Original: D7VY-8592A C8SZ-8592A</p>
<p>7128</p>  <p>FORD Americana Ford Series E-F 100/350 Econoline Van y Pick-up 73/79, P 600 Step Van y Parcel Delivery '78 V-8 Maq. 300 y 240 No. Original: D3TZ-8592A</p>	<p>7130</p>  <p>FORD Americana Ford Fiesta w/o A/C 1.6L 4 Cil. 78/80 No. Original: D8RZ 8592-A</p>	<p>7136</p>  <p>FORD Americana Ford F 100, 350, Econoline, Pick-up 460 7.5L 78/85; California 86/87 No. Original: E5TZ-8592C D8TZ-8592A</p>	<p>7152</p>  <p>FORD Americana Topaz Tempo, Pinto con A/A Maq. 140 2.3L 78/88, Ranger 4 Cil. C/A All Ford & Mercury , Except HSCc78/82; All Ford & Mercury, Except Ford Tempo & Mercury Topaz 86/88 LPG 83/85 No. Original: D8FZ-8592A</p>

TOMAS DE AGUA Water Outlet



6

<p>7166</p>  <p>FORD Americana Ford Bronco, Econoline, F-100 Maq 351 y 400 80/81 Cañon Largo F-150 80/81; F-250 y F-350 80/82; E-100, E-150, E-250 y E-350 Econoline 80/82 No. Original: E0TZ-8592A</p>	<p>7168</p>  <p>FORD Nacional Bronco, E-150 Econoline, F100, 150, 250, 350 4.9L 6 Cil. 80-83 (carburado) Americana Bronco 6L 4.9L 85-86, E-150, 250, 350, Econoline 6L 4.9L 73-82 F-100, 350 Pick-up 250 6Cil. 4.9L 74-83 No. Original: E0TZ-8592B</p>	<p>7202</p>  <p>FORD Nacional Cougar y Thunderbird 85/up F-150 y F-200 86/up Americana Mustang 6 Cil 3.8L, Mercury todos V-6 230 3.8L 80/88 F-100 Pick up V6 82/84 Lincoln todos 80/87 No. Original: E2DZ-8592A E3DZ-8592A</p>	<p>7217</p>  <p>FORD Nacional y Americana Alojamiento para bomba de agua Ford 4 Cil. Motor 140 2.3L Topaz de 1984/Up No. Original: E53E-8508AA Ref.: 8508</p>
<p>7219</p>  <p>FORD Americana Ford Mustang y Mercury Capri V-6 230 3.8L '85 No. Original: E3ZZ-8592A</p>	<p>7220</p>  <p>FORD Americana Ford Bronco II y Ranger lado frontal 6 Cil 2.8L 83/85 No. Original: E4TZ-8592L E3TZ-8592L</p>	<p>7222</p>  <p>FORD Americana Ford y Mercury Todos except Turbo, Ford Tempo y Mercury, Topaz Maq 140 83/91 No. Original: E3BZ-8592A</p>	<p>7223</p>  <p>FORD Americana Bronco II y Ranger Aerostar 2.0, 2.3L 4 Cil 83/88, F 100 350 6 Cil 84/87 No. Original: E4TZ-8592B</p>
<p>7258</p>  <p>FORD Nacional Bronco, E-150 Econoline, F150, 250, 350 4.9L 6 Cil. 85/90 (carburado) Americana Bronco 6L 4.9L 80/84 E-150 Econoline 6L 4.9L 85/90 F-150 Pick-up 6Cil. 4.9L 85/89 F-250 Pick-up 6Cil. 4.9L 85/87, F-350 Pick-up 6Cil. 4.9L 85/89, No. Original: E5TZ-8592E E7TZ-8592B</p>	<p>7261</p>  <p>FORD Americana Bronco II, Ranger 2.9L 6 Cil. 86/92 No. Original: E6TZ-8592A</p>	<p>7262</p>  <p>FORD Americana F 250, 350 Van, Pick-up Excep California 460 V-8 86/87 No. Original: E5TZ-8592D</p>	<p>7263</p>  <p>FORD Americana Tempo, Topaz, Taurus Excep Super High Output, Sable, Probe 3.0L V-6 86/94 Ford y Mercury 86/95 No. Original: E8DZ-8592A</p>
<p>7264</p>  <p>FORD Nacional Ford V6 motor 230 3.8L Taurus Americana Aerostar 3.0L, Taurus, Mercury Sable 3.8L V-6 86/93 (Altura: 53.16 mm) No. Original: E8DZ-8592B E69Z-8592A</p>	<p>7268</p>  <p>FORD Nacional Bronco, E-150 Econoline, F100, 150, 250, 350 4.9L 6 Cil. 90/97 (F.) Americana F-150, 250, 350, Pick-up 6Cil. 4.9L 91/96; Ford 90/97 No. Original: F0TZ-8592H F5TZ-8592BA</p>	<p>7269</p>  <p>FORD Nacional Topaz FI 4 Cil 2.3L 89/91 c/doble barreno para bulbo de motoventilador y temp. (carburado) Americana Ford Tempo & Mercury todos 2.3L 4 Cil. 88/94 No. Original: E93Z-8592A</p>	<p>7270</p>  <p>FORD Nacional F 150, 350 Econoline Van, Pick-up 8 Cil 97/00 Windstar 6 Cil 97/05 Americana F 150/350 Econoline Van & Pickup Truck 8 Cil 97/00 No. Original: F75Z-8592CA</p>

TOMAS DE AGUA Water Outlet



			
<p>7271</p> <p>FORD Nacional Topaz FI 4 Cil 2.3L 92/94 c/un barreno para bulbo de temperatura Americana Tempo & Topaz 2.3L 4 Cil. 92/94; Thunderbird & Cougar 6 Cil. 3.8L 93/96 No. Original: F23Z-8592A</p>	<p>7272</p> <p>FORD Nacional Escort ZX2 4Cil. 1.28, 1.9 Y 2.0L 98/03 Americana ZX2 2.0L 4 Cil. 00/03 No. Original: XS4Z-8592-TB</p>	<p>7273</p> <p>FORD Nacional Housing Focus dos árboles 16V 4 Cil. 2.0L 00/04 (Aplica para 7280) Americana Contour & Mystique 00 , Cougar 00/02 2.0L 4 Cil. Escape 01/04; Focus 02/04; Focus LE 00 y S2 02 No. Original: YS4Z-8592-BD</p>	<p>7273-H</p> <p>FORD Nacional y Americana Housing (con barrenos para sensor de temperatura a presión y de motoventilador) Focus un árbol SPY 16V 2.0 02/03 (Aplica para 7280) No. Original: YS4Z8592AD</p>
			
<p>7274</p> <p>FORD Nacional y Americana Ford Fiesta, Ikon y Ka 4 Cil 1.4 y 1.6L (tortuga) TODOS No. Original: MXS6-E8250-AD</p>	<p>7274-H</p> <p>FORD Nacional y Americana Housing Ford (con junta) Fiesta, Ikon y Ka 4 Cil. 1.4 y 1.6L (7274) Courier (7275) TODOS No. Original: M5S6-G9K478-AA</p>	<p>7274-H-E</p> <p>FORD Nacional y Americana Housing Ford (con junta) ECONÓMICO Fiesta, Ikon y Ka 4 Cil. 1.4 y 1.6L (7274) Courier (7275) TODOS No. Original: M5S6-G9K478-AA</p>	<p>7274-H-T</p> <p>FORD Nacional y Americana Housing Ford (con junta y termostato) Fiesta, Ikon y Ka 4 Cil. 1.4 y 1.6L (7274) Courier (7275) TODOS No. Original: M2S6-G8A586-D1C</p>
			
<p>7274-H-T-E</p> <p>FORD Nacional y Americana Housing Ford (con junta y termostato) ECONÓMICO Fiesta, Ikon y Ka 4 Cil. 1.4 y 1.6L (7274) Courier (7275) TODOS No. Original: M2S6-G8A586-D1C</p>	<p>7274/Kit</p> <p>FORD Nacional y Americana Ford Fiesta, Ikon y Ka 4 Cil. 1.4 y 1.6L TODOS (Housing, toma de agua, junta, termostato, oring, sensor y seguro desensor) No. Original:XS6E-8A586-AL</p>	<p>7274/Kit-E</p> <p>FORD Nacional y Americana ECONÓMICO Ford Fiesta, Ikon y Ka 4 Cil. 1.4 y 1.6L TODOS (Housing, toma de agua, junta, termostato, oring, sensor y seguro desensor) No. Original: XS6E-8A586-AL</p>	<p>7275</p> <p>FORD Nacional y Americana Ford Courier 4 Cil 1.6L (alacrán)TODOS (Housing, toma de agua, sensor y seguro desensor) No. Original: 2S6G-8250-A1B</p>
			
<p>7275/Kit</p> <p>FORD Nacional y Americana Ford Courier 4 Cil. 1.6L TODOS (Housing, toma de agua, junta, termostato, oring, sensor y seguro de sensor) No. Original: M2S6G-8A586-D1C</p>	<p>7275/Kit-E</p> <p>FORD Nacional y Americana ECONÓMICO Ford Courier 4 Cil. 1.6L TODOS (Housing, toma de agua, junta, termostato, oring, sensor y seguro de sensor) No. Original: M2S6G-8A586-D1C</p>	<p>7274-75-Kit-E</p> <p>FORD Nacional y Americana ECONÓMICO Ford Fiesta, Ikon y Ka 4 Cil.1.4 y 1.6L TODOS, Ford Courier 4 Cil 1.6L (alacrán) TODOS (Housing, toma de agua (2), junta, termostato, oring, sensor y seguro de sensor)</p>	<p>7276</p> <p>FORD Nacional Housing Contour y Mystique 6Cil. 2.4L 95/99 (Aplica para 7277) Americana Contour 99; Escort 98/99; Cougar, Mystique 99 2.0L 4 Cil. No. Original: F5RZ-8592B</p>

TOMAS DE AGUA Water Outlet



8

7277



FORD

Nacional
Contour, Mystique 2.0 4 y 6 Cil. 95/01
Americana
Contour, Mystique 2.0
4 y 6 Cil. Mercury 95/00
Focus LE, ZTS, S2, SE, ZX3, STREET 00/01
No. Original: F5RZ-8592-A

7277/Kit



FORD

Nacional
Bronco, E-150 Econoline,
F100, 150, 250, 350 4.9L 6 Cil. 80-83 (carburado)
Americana
Bronco 6L 4.9L 85-86, E-150,
250, 350, Econoline 6L 4.9L
73-82 F-100, 350 Pick-up 250 6v Cil. 4.9L 74-83
No. Original: E0TZ-8592B

7278



FORD

Nacional y Americana
Ford Ranger 2.3L 4 Cil. 93/97
No. Original: F2TZ-8592-AA

7279



FORD

Nacional
Ford Ranger 3.0 L 6 Cil.
91/95; Ford Ranger 6 Cil. 3.0L 98/03
Americana
Ranger 00/01 3.0L 6 Cil
Ranger Edge '01 3.0L 6 Cil Ford 91/01
No. Original: XL5Z-8592 AB

7280



FORD

Nacional
Ford Focus 16V 4 Cil. 2.0 00/04, Escape 2.0L 01/04
Americana
Escape 01/04 Focus S2,
Street 01/02; SE, ZTS,
ZX3 01/04; ZTW 02/03 ZX5 02/04
No. Original: XS4Z8592AC

7280/Kit



FORD

Nacional
Ford Focus 16V 4 Cil. 2.0 00/04
(Housing 7273 y toma de agua 7280)
No. original: YS4Z-8592-BD
XS4Z8592AC

7281



FORD

Nacional y Americana
Ranger 6V 3.0 95/97
No. original: F5TZ8592AA

7282



FORD

Nacional
Ford Ranger 4.0 L 6 Cil. 90/00
Motor OHV 35 milímetros
Americana
Ranger, Explorer 4.0L 6Cil. '00 Ford 90/00
No. Original: F0TZ-8592 CA

7283



FORD

Nacional y Americana
CON ENTRADA PARA SENSOR
Ford Ranger 2.3L 4Cil. 93/97
No. Original:
F57Z-8592-AB

7284



FORD

Nacional
Windstar freestar 03/07 3.8L 6 Cil.
Americana
Ford Windstar 96/03 3.8L 6 Cil.
Freestar y Freestar SE 3.9L 6
Cil. Freestar limited y sel 07
4.2L 6 Cil. Mercury Monterey 07 4.2L 6 Cil. (Altura: 57.26 mm)
No. Original: F78Z-8592-BA y F78Z-8592-BB

7285



FORD

Nacional
CON SENSOR Y TERMOSTATO
Ford Ecosport 2.5L 4 Cil. 04/Up, Focus 2.0L 4 C
05/06, Ranger 2.0L 4 Cil. 01/04, Mondeo todos.
Americana
Ecosport w sensor 4 Cil 2.5L 04/Up
No. Original: 1S7Z-8575-AG

7286



FORD

Nacional
CON TERMOSTATO SIN SENSOR
Ford Escape 2.5L 4 Cil. 07/Up, Focus 05/07,
Fusión 06/08, Ranger 04/08, Ecosport 2.5L 4 Cil. 04/Up
Americana
Escape 07/Up; Ecosport w/o sensor 04/Up 4 Cil. 2.5L
No. Original: 3M4Z-8575-B

7287



FORD

Nacional y Americana
Ford Escape 3.0L 6 Cil. 01/04
No. Original: YL8Z-8592-AB

7288



FORD

Nacional y Americana
Ford Escape 3.0L 6 Cil. 05/08
No. Original: 2M5Z-8592-CD

7289



FORD

Nacional y Americana
Ford Escape 3.0L 6 Cil. 09
No. Original: 9L8Z-8592-A

7290



FORD

Nacional
Ford Explorer 4.6L 89/04
Americana
Ford Explorer 4.0 L 6 Cil. 97/01, Mercury Mountaineer
4.0 L 6 C. 98/01, Ranger 4Cil. 4.0L 02/UP
(Aplica para housing 7295)
No. Original: F7TZ-8594-A

7290/Kit

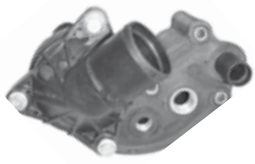

FORD
Nacional
Ford Explorer 4.6L 89/04
Americana
Ford Explorer 4.0 L 6 C.
97/01, Mercury Mountaineer
4.0 L 6 Cil. 98/01, Ranger 4 Cil. 4.0L 02/UP
(Housing 7295 y toma de agua 7290)
No. Original: F7TZ-8594-A

7291



FORD
Nacional
Crown Victoria Grand Marquis 8 Cil 4.6L 96/99
Americana
Town Car 8 Cil 4.6L 91/95
Ford 97/07; Lincoln 98/99
No. Original: F1VY-8592A

7292



FORD
Nacional
Escort 16 V 4 Cil 1.6L 98/99
Americana
Ford ZX2 2.0L 4 Cil.
No. Original: F8RZ-8592-AC

7293



FORD
Nacional
Ford Explorer 4.0 00/UP Ranger 4 Cil. 4.0L 97/01
(Aplica para housing 7294)
Americana
Explorer 01/05, Explorer
Sport 01/03, Mountaineer 01/04 4.0L 6 Cil.
Ranger 02/04 3.0L 6 Cil.
No. Original: 2L2Z-8592-AA

7293/Kit



FORD
Nacional
Ford Explorer 4.0 00/UP
Ranger 4 Cil. 4.0L 97/01
(Housing 7294 y toma de agua 7293)
No. Original: YU3Z8A586AA

7294



FORD
Nacional
ENTRADA PARA UN SENSOR A PRESION
Housing Ford Explorer 4.0
00/UP, Ranger 4 Cil. 4.0L
97/01, Mustang V6 12V 4L 8 Cil 06/10
(Aplica para T.A. 7293 y 7313)
No. Original: 2L2Z-8592-BA

7295



FORD
Nacional
ENTRADA PARA 2 SENSORES CON ROSCA
Housing Ford Explorer 4.6L 89/04,
Ranger 4 Cil. 4.0L 02/UP
Americana
Explorer 97/00 Mountaineer 98/00
(Aplica para T.A. 7290)
No. Original: 2L5Z-8592-BB

7296



FORD
Nacional
Ford Escort 4 Cil 2.0L 97/00
No. Original:
F8CZ-8592-AA

7297



FORD
Nacional y Americana
Ford Ranger 2WD 4 Cil 2.3L 89/91
No. Original: F87Z-8592-AM

7298



FORD
Nacional y Americana
Ford Thunderbird V8 3.9L 03/05
Lincoln LS V8 3.9L 03/06
No. Original: 3W4Z-8592-AA

7299



FORD
Nacional y Americana
CON TERMOSTATO
Ford E-300 y 450 Econoline
V8 6.0L 04/05, E-350 Super
Duty V8 6.0L 06/08, Excursion
V8 6.0L 03/05, F-250 y 350 V8
6.0L 03/07, F-450, 500 y 550
Pick Up V8 6.0L 05/07 F-450
Super Duty V8 6.0L 03/04 (Altura: 78.75 mm)
No. Original: 3C3Z 8575 AA

7300



FORD
Nacional y Americana
CON TERMOSTATO,
SENSOR Y SEGURO
Ford Focus 2.0L 4 Cil. 01/03
No. Original: 2M5Z-8592-AC

7301



FORD
Nacional
Mustang Cobra, GT V8
4.6L 96/03, Cougar V6 2.5L 99/02, Sable 3.0L
01/02, Contour V6 2.5L
98/00, Mystique V6 2.5L 99/00
Americana
Contour SVT '00; Cobra 01/04, Mach1 03/04;
Taurus 01/05; Lincoln LS 00/05; Cougar 00/02;
Marauder 03/04; Mystique '00 Sable 00/05, Lincoln y
Mercury 96/05
No. Original: F6ZZ-8592BB

7302



FORD
Nacional
Ford V8 4.6L, Crown Victoria 99/03, Grand
Marquis 98/03, Mustang GT, Cobra 96/03,
Thunderbird, Cougar 96/97
Americana
Mustang GT '00 8 Cil. 4.6L Mustang Bullitt, GT '01
8 Cil. 4.6 L, Mercury 96/97
No. Original: F6ZZ-8592C

7303



FORD
Nacional
Ford V6 3.0L Taurus 1999,
Taurus G/GL/LX, Sable 96/03, Aerostar,
Ranger/Super 96/97
Americana
Taurus y Sable 00/05 Taurus SE & SEL 06/07
6 Cil. 3.0L, Mercury 96/05, Subaru 78/79
No. Original: YF1Z-8592CA

7304



FORD
Nacional
Expedition motor V8 24V
5L 8 Cil 04/08
No. Original: 3L3Z-8592-AA

<p>7305</p> 	<p>7306</p> 	<p>7308</p> 	<p>7309</p> 
<p>FORD Nacional Econoline 00/04; Excursion 01/05; F-250, F-350, F-450 y F-550 04/09 10 L 8 Cil. Americana E Super Duty 00/02; E 350 Econoline, Excursion, F-250/350/450/550, Super Duty Pick up 00/03; E450 Econoline, E550 Super Duty Custom 03 7.3L 8 Cil. No. Original: F81Z8592AA</p>	<p>FORD Nacional Econoline 7.3L 8 Cil. 00/04 Americana E-350 94/03; Econoline Super Duty 96/99; F250/350 Super Duty 94/97 7.3L 8 Cil. No. Original: F4TZ8592AA</p>	<p>FORD Nacional Escape 03-07 6 Cil 4.0L, Fusion 06-07 6 Cil 3.8L Americana Ford Escape 01-07, Fusion 06-07, Mercury Mariner '07, Mercury Milan 06-07 6 Cil. 3.0L No. Original: YL8Z8K528AE</p>	<p>FORD Nacional Fiesta 95/98 4 Cil. 5.0L No. Original: 98MM-9K478-DA 98MM-9K478-DB</p>
<p>7310</p> 	<p>7311</p> 	<p>7310/Kit</p> 	<p>7312</p> 
<p>FORD Nacional Explorer Sport TU 01/03 8 Cil 5.0L No. Original: 2L5Z-8592-BB</p>	<p>FORD Nacional Housing (entrada 2 sensores a presión) Explorer 07/10, Explorer Mountaineer 07/10, Mustang 05/10 8 Cil 5.0L (Aplica para T.A. 7310 y 7312. No. Original: 2L2Z-8592-BA</p>	<p>FORD Nacional (Housing 7311 y T.A. 7310) Explorer 07/10, Explorer Mountaineer 07/10, Mustang 05/10 8 Cil 5.0L; Explorer Sport TU 01/03 8 Cil 5.0L No. Original: 2L2Z-8592-BA y 2L5Z-8592-BB</p>	<p>FORD Nacional Ranger 03/07 6Cil 3.0L No. Original: 4L5Z-8592-AA</p>
<p>7312/Kit</p> 	<p>7313</p> 	<p>7313/Kit</p> 	<p>4301</p> 
<p>FORD Nacional (Housing 7311 y T.A. 7312) Ranger 03/07 6Cil 3.0L; Explorer 07/10, Explorer Mountaineer 07/10, Mustang 05/10 8 Cil 5.0L No. Original: 2L2Z-8592-BA y 4L5Z-8592-AA</p>	<p>FORD Nacional Explorer sport track 06/10 6 Cil 4.0L No. Original: 6L2Z-8592-FA</p>	<p>FORD Nacional (Housing 7294 y T.A. 7313) Explorer sport track 06/10 6 Cil 4.0L; Housing Ford Explorer 4.0 00/UP, Ranger 4 Cil. 4.0L 97/01, Mustang V6 12V 4L 8 Cil 06/10</p>	<p>FIAT Nacional y Americana Fiat Palio, Siena y Strada 1.6L 8V 98/00 No. Original: 7778655</p>
<p>6013</p> 	<p>6034</p> 	<p>6037</p> 	<p>6039</p> 
<p>GENERAL MOTORS Americana All Chevrolet 265, 283, 327, 348 55-65; Fuel Injection, Dual 4 Bbl. Carb., & Special Hi Performance 56-62; Checker 65-67; All Pontiac 61-63; C-K 10/30 Pick-up, G Van, P 10/30 Step & Value, Suburban, Blazer 66-67; All C-K 10/30 Pick-up, G 10/30 Van, P 10/30 Step Van & Value Van, Suburban, Blazer, Except A.J.R. 55-65; C-K 15/35 Pick-up, G 15/35 Van, P 25/35 Step Van & Value Van, Suburban, Jimmy 66-67, Chevy y GMC 55/68 No. Original: 3837223, 538366 3705018, 3827370</p>	<p>GENERAL MOTORS Americana All Buick 400,401,425 8 Cil 64/66 Electra, Riviera, Wildcart 8 Cil. 62/65 No. Original: 1350825</p>	<p>GENERAL MOTORS Nacional GM 6 cil. 230, 250, 292 Buick todos 250 68/73; Vona, Chev II 327 64/65; GMC Todos C-K 15/35 Pick-up Suburban, Jimmy, G 15/35 Van, P 25/35 Van 6 Cil 67/73 All Chevrolet C-K 10/30 Pick-up, Suburban, Blazer, G 10/30 Van, P 10/30 Van & Value Van Chevy 63/73; GMC 65/73; Olds 66/71; Pontiac 64/65 No. original: 3789162</p>	<p>GENERAL MOTORS Americana All Chevrolet 6 Cil 63-66 Vega 122 4 Cil 75/76 All, Except Monza & Vega 140 4 Cil. 68/71 All Checker 230 6 Cil. 65/67 Chevy 64/76 No. Original: 3841191</p>

<p>6040</p>  <p>GENERAL MOTORS Americana Chevrolet todos C-K 10/30 Pick-up, Suburban Blazer, P 10/30 Van 292 59/62, Chevy y GMC 65/78 No. Original: 3836209 y 329223</p>	<p>6057</p>  <p>GENERAL MOTORS Americana Pontiac todos Except 65 Tempest V-8 65/70 Pontiac 64/70 No. Original: 9779072 9779073, 9775237</p>	<p>6071</p>  <p>GENERAL MOTORS Americana Chevrolet Corvette Hi Performance 65/68 Camaro 302 67/68; 327, 427 65/68 Corvette Except FI 62/65; w/4 Bbl. Carb 55/61 8 Cil. Chevy 63/68 No. Original: 3827369 y 3795013</p>	<p>6082</p>  <p>GENERAL MOTORS Americana Cadillac 500 8 Cil '76 All Cadillac, Except Seville 68/75 No. Original: 1486784</p>
<p>6092</p>  <p>GENERAL MOTORS Americana Buick Regal 250 82/95; All Cadillac Seville 350 76/79; Cadillac, Fleetwood RWD 90/90; Oldsmobile Cutlass Supreme 260 82/94; All C hevrolet 307Y 350N Diesel 80/90; El camino, Malibu, Montecarlo 82/84; All Oldsmobile Except 75 73/75 y 76 76/81 Omega; Ventura 75; All Pontiac diesel 92/90; C-K Pick up, Suburban Blazer diesel 78/81; Buick y Cadillac 76/90; Chevy 78/90; GMC 78/84; Olds 66/90; Pontiac 75/89 No. Original: 409037 y 547082</p>	<p>6098</p>  <p>GENERAL MOTORS Americana AMC 4 Cil 80/85 Chevrolet Astro Van, S10 Pickup & Blazer 6 Cil 2.5L All Buick V6 400 All Cadillac V 8 87/92 AMC 80/83; Chevy 78/90; GMC 78/84; Olds 66/90, Pontiac 75/89 No. Original: 478144, 489869, 9782138, 10021153, 10008866, 81321236, 8132282</p>	<p>6099</p>  <p>GENERAL MOTORS Americana Buick 260, 350R, 403, 455 75/80, Cadillac, Fleetwood RWD 307Y 5.0L, 350 5.7L 76/90, El Camino, Malibu, Monte Carlo 173 2.8L, V-6 260 4.3L 82/84; All Chevrolet C-K 10/30 Pickup, Suburban, Blazer, G 10/30 Van, P 10/30 Step Van & Value Van, Except 250 w/Integral Head 78 Buick 68/75; Chevy 64/79; GMC 65/78; Olds 68/76; Pontiac 70/76 No. Original: 338117</p>	<p>6103</p>  <p>GENERAL MOTORS Americana Buick todos Chevy 305, 350 Chevrolet P 10/30 Van, GMC todos P 25/35 Van 8 Cil 73/79; All Chevrolet C-K 10/30 Pickup, Suburban & Blazer V8 78/79 Except Diesel; Jimmy 73/77 Buick 77/79; Chevy 65/81; GMC 67/81; Olds 77/78; Pontiac 71/78 No. Original: 336773 y 336790</p>
<p>6122</p>  <p>GENERAL MOTORS Americana Chevrolet P 10/30 Van 8 Cil Except 6.2L Diesel 81/82 V-8 G 10/30 Van 8 Cil 73/74, P10/30, California 350, 454 7.4L 77/78 Chevy y GMC 73/86 No. Original: 14007353, 346219 354415 y 14088522</p>	<p>6132</p>  <p>GENERAL MOTORS Americana Chevrolet 200 8Cil maq 350 78/79 Buick 77/81; Chevy 74/93 GMC 76/91; Olds 78/83; Pontiac 77/92 No. Original: 469518</p>	<p>6133</p>  <p>GENERAL MOTORS Americana Chevrolet C-K 10/30 Pick-up Suburban, Blazer, G 10/30 Van 250 '78, Cadillac todos Excepto Seville 78/79, Cadillac todos 4.1, 7.0 L 80/85 No. Original: 465999</p>	<p>6137</p>  <p>GENERAL MOTORS Americana Buick todos (H, J, X) 8 Cil Buick (A, G, 3) V-6 3.2, 3.8 5.7 y 7.5L 77/79; All Buick 231 V6 75/76, All Chevrolet A,G,3 196 y 231 78/79 Buick 65/79; Chevy 78/80; GMC 78/79; Jeep 66/71; Olds 75/79; Pontiac 76/79 No. Original: 12470974 y 1254774</p>
<p>6155</p>  <p>GENERAL MOTORS Americana Chevrolet Chevette 4 Cil. 1.6L 79 y 81 No. Original: 14001154</p>	<p>6156</p>  <p>GENERAL MOTORS Americana Buick Skylark, Citation, Oldsmobile Omega, Pontiac Phoenix, Ciera Pontiac 6000 151 2.5L (R,5) 80/90 No. Original: 10005894, 10019470</p>	<p>6157</p>  <p>GENERAL MOTORS Americana Buick Skylark, Apollo Special 173 2.8L, Century Celebrity, Oldsmobile Ciera, Pontiac 6000 260 4.3L (T) Diesel 80/86 Chevy 80/85 No. Original 477202 y 22512846</p>	<p>6158</p>  <p>GENERAL MOTORS Americana Chevrolet C-K 10/30 Pick-up Suburban, Blazer, G 10/30 Van, Nova, Except California 250 78/84 Chevy 77/84 y GMC 79/84 No. Original: 14001969</p>

TOMAS DE AGUA Water Outlet



12

<p>6161</p> 	<p>6162</p> 	<p>6163</p> 	<p>6164</p> 
<p>GENERAL MOTORS Nacional GM V-8, autos, camiones y camionetas con maq. 350 79/80 Americana Chevrolet Todos C-K 10/30 Pick-up Suburban, Blazer 8 Cil Excepto 6.2L Diesel V-8 80/84, Corvette 8 Cil 79/81 267, 305,350 5.7, 6.6 y 7.4L (G.L) Buick 77/81; Chevy 74/93 GMC 76/91; Olds 78/83; Pontiac 77/92 No. Original: 469519, 469518, 14088753, 14014427</p>	<p>GENERAL MOTORS Nacional Cutlass, Century C/Bulbo Moto Ventilador 5/8 Skylark (W), Cimarron(W) FI, Cavalier 173 2.8L, Chevette 1.6L 85/86 Americana Chevette 1.6L; Skylark (W) 2.8L 85, Cimarron (W) Fuel Injection, Cavalier (2.8L) (W); Celebrity (2.8L) (W); Citation (2.8L) (W) ; Ciera (W) Firezza (W) 6000 (2.8L) (W) H.O. 85/86; Cadillac 85/86; Chevy 79/87; Olds 85/86; Pontiac 81/87 No. Original: 14001120</p>	<p>GENERAL MOTORS Americana Buick Todos 350 V-8 Electra, LeSabre, Regal 231A V-6, Canada, Malibú, Caprice, Oldsmobile, Pontiac 231 3.8 y 5.7L 80/84; Wildcat Engine - Canada; Riviera (3.8L) w/4 Bbl. Carb; BelAir, Biscayne, Caprice, Impala, Brookwood, Kingswood; All Chevrolet (A) Engine, California; El Camino, Malibu, Monte Carlo & 2 Bbl. No. Original: 25502660 y 25513298</p>	<p>GENERAL MOTORS Americana Fleetwood, De Ville 4.1 80/81; All Cadillac (4.1L) V6, w/EFI 82, All Cadillac (4.1L) 80/84; All Chevrolet (A) & Fed. Emissions 84/85 Air, Except California 6 82, Biscayne, Except California 82 Caprice (A) Engine w/Closed Loop V6 81 Oldsmobile 98 (3) 85 Regency (3) 85; Buick 80/81; Cadillac 82; Chevy 81; Pontiac 81/87 No. Original: 25502661, 25509087</p>
<p>6165</p> 	<p>6182</p> 	<p>6185</p> 	<p>6186</p> 
<p>GENERAL MOTORS Americana Cadillac todos 368 V-8 80/84 5.0L EFI, Chevrolet todos, Pontiac V-6 229 3.8L No. Original: 1616501</p>	<p>GENERAL MOTORS Americana Chevrolet todos C/Bulbo Pontiac V-6 229 81/84 No. Original: 14024297</p>	<p>GENERAL MOTORS Americana Chevrolet Camaro, Pontiac Firebird V-8 5.0L EFI, Chevrolet Pontiac todos V-6 229 80/82 No. Original: 14014426 y 14037618</p>	<p>GENERAL MOTORS Americana Buick Skylark, Cavalier Oldsmobile Firezza, Pontiac J2000, Except OHC 82/86, Cadillac Cimarron todos 4Cil No. Original: 14018750</p>
<p>6190</p> 	<p>6191</p> 	<p>6199</p> 	<p>6209</p> 
<p>GENERAL MOTORS Americana Camaro (2.8L), Pontiac Firebird, Cherokee, Comanche, Wagoneer, S10 Pick-up, Blazer S15 Pick-up, Jimmy 82/85 Chevy y GMC 82/85, Jeep 86, Pontiac 82/84 No. Original: 14033082</p>	<p>GENERAL MOTORS Nacional y Americana Century, Celebrity, Skylark Apollo 173 2.8L (X,Z, V6 82/86, Oldsmobile Ciera, Pontiac 6000, Phoenix Exp HO y Omega 173 2.8L 82/87; Buick, Chevy, Olds 82/86; Pontiac 80/86 No. Original: 14092928 y 14033198</p>	<p>GENERAL MOTORS Americana Blazer, Jimmy, Suburban Crew Cab, Cab Oldsmobile 89/90, Cutlass, California 5.0 y 5.7L '83; Camaro 8 C 85/89 Corvette 8 C '82,84; All Pontiac Except 82 firebird w/5.0L w/Fuel Injection 82/84; Buick 82/85; Chevy 81/90; GMC 82/86; Olds y Pontiac 82/87 No. Original: 1403376, 14087075, 14043376</p>	<p>GENERAL MOTORS Americana Chevrolet P 10/30 Step Van & Value Van, GMC 25/35, Chevrolet C-K 10/30 Pickup, Suburban & Blazer GMC C-K 15/35 & Jimmy V8 6.2L diesel Chevy y GMC 82/91 No. Original: 14028918</p>
<p>6210</p> 	<p>6230</p> 	<p>6233</p> 	<p>6234</p> 
<p>GENERAL MOTORS Americana Oldsmobile Ciera, 98 Regency V-6 181 3.0L E Century, Electra V-6 183 3.0L 82/85 Buick y Olds 82/85 No. Original: 25500204</p>	<p>GENERAL MOTORS Americana Monte Carlo, El Camino 231 Cutlass, Pontiac todos 231 6 Cil 85/87 Buick 82/88; Chevy 84/87; GMC 84; Olds 80/87; Pontiac 82/87 No. Original: 25517009 y 25523589</p>	<p>GENERAL MOTORS Nacional Toma S/10 2.2 4 Cil. 95/03 Americana Buick Skyhawk, Cavalier y Beretta 4C 2.2 L. 93-96, Oldsmobile 2.0L, Corsica 4C 2.2L 87/96, Century 4C 2.2L 93/96, Vehicle 4C 2.2L. 94/95, Cutlass Ciera 4C 2.2L. 93/94 Sunfire 4C 2.2L. 95/96 No. Original: 14090036 y 10103619</p>	<p>GENERAL MOTORS Americana Buick todos, Oldsmobile, Pontiac, Boneville 3.8L 6 Cil '88 No. Original: 25532950</p>

<p>6235</p> 	<p>6236</p> 	<p>6237</p> 	<p>6238</p> 
<p>GENERAL MOTORS Americana Cadillac Deville, Fleetwod 4.5L V-8 '90, El Dorado, Deville, Seville, Fleetwod 4.9L V-8 91/92 Cadillac 85/95 No. Original: 1625774 y 3520936</p>	<p>GENERAL MOTORS Nacional GM V6 motor 189 3.1L Cutlass 88/96, Cavalier 90/91 Americana Beretta, Cavalier 3.1L 6C 90/91, Cimarron 2.8L HO 87/88, Pontiac 6000 3.1L 87/89 (sin entrada) No. Original: 14092251</p>	<p>GENERAL MOTORS Americana Chevrolet Camaro, Pontiac Firebird 5.0L Except TBI 5.7L 8 Cil 87/92; Monte Carlo w/5.0L Engine, California '88 Chevy 85/92, GMC 86, Pontiac 85/92 No. Original: 14084383</p>	<p>GENERAL MOTORS Nacional y Americana Suburban, Silverado, Microbus TBI Nacional, Blazer, Jimmy, Crew Cab, Chassis Cab 5.7L V-8 89/91 Cadillac 90/92; Chevy y GMC 88/96 No. Original: 14102149 y 10110827</p>
<p>6239</p> 	<p>6240</p> 	<p>6241</p> 	<p>6242</p> 
<p>GENERAL MOTORS Americana Buick LeSabre, Electra Park Eve, Oldsmobile Delta 88, Regency 98 Regal 3.8L 231 Turbo, Ciera 86/88; Pontiac Firebird 89 y Bonneville 3.8L 87/89 No. Original: 25522194</p>	<p>GENERAL MOTORS Americana Chevrolet 6 Cil. 4.3L 85/99 C10/30 Pick up, K10/30 G10/30 Van Astrovan 510 Pick up, Blazer C15/35 Pick up K15/35 Van, Safari Van S15 Pick up Jimmy. Cadillac y GMC 85/96 Olds 91/92 No. Original: 14081284</p>	<p>GENERAL MOTORS Americana Full Size G Series GM Van V-8 454, 5.0 y 5.7L 83/91 Chevy y GMC 83/91 No. Original: 14055159</p>	<p>GENERAL MOTORS Nacional y Americana Chevrolet ST 10 y GMC ST 15 2.8L V-6 173R 86/91 Chevy 86/93; GMC 86/93; Isuzu 91/94 No. Original: 14091876</p>
<p>6243</p> 	<p>6245</p> 	<p>6246</p> 	<p>6247</p> 
<p>GENERAL MOTORS Americana Buick, Oldsmobile, Pontiac, Bonneville 3.8L 88/91 No. Original: 25535941</p>	<p>GENERAL MOTORS Americana Buick Regal, Outlass Supreme, Pontiac Grand Prix 2.8 y 3.1L 88/93 Chevrolet Lumina 3.1L 90/93; Chevy 90/94; Olds 88/94 No. Original: 10065502 y 14100587</p>	<p>GENERAL MOTORS Nacional General Motor V-6 Motor 173 2.8L y 189 3.1L. Cavalier 92/95 Americana Chevrolet Lumina APV Oldsmobile Silhouette, Pontiac Transport 3.1L 90/94 (con entrada) No. Original: 10151684</p>	<p>GENERAL MOTORS Nacional y Americana C 1500, 2500, 3500 Pick-up, Suburban 92/95, G 10, 20, 30, Van 92/95, K 1500, 2500 3500 Pick-up 92/95, P 30 Van 92/95 Tahoe '95 No. original: 10147884 y 10172831</p>
<p>6250</p> 	<p>6251</p> 	<p>6255</p> 	<p>6255-T</p> 
<p>GENERAL MOTORS Americana Rivera Electra, LeSabre, Est Wagon, Park Ave, Olds Ninety-eight, Tornado, Regal, Reatta, Lumina APV, Silhouette Delta 88, Custom, Crusier, Pontiac, Transport 3.8L 6 Cil 90/93 Buick 90/94; Chevy 92; Olds 91/92; Pontiac 92 No. Original: 24500500</p>	<p>GENERAL MOTORS Nacional y Americana GM V-8, Autos, Camiones y Camionetas 350 73/Up (Sin entradas) No. Original: 14014427</p>	<p>GENERAL MOTORS Nacional Chevy Corsa 4 Cil. 1.4L y 1.6 L 94/02 Americana Opel, Chevy, Monza, Corsa 1.4L y 1.6L 94/02 Pontiac Lemans 1.6L 4 Cil 88/93 No. Original: 90234805</p>	<p>GENERAL MOTORS Nacional Chevy vagoneta (Pick Up) 4 Cil 1.6 L 02-Up, Corsa, Meriva y Tornado 1.8 V8 02/08 con liga y termostato Americana Chevy Pickup 4 Cil.1.6L 02/Up No. Original: 93275736</p>

TOMAS DE AGUA Water Outlet



14

6256



GENERAL MOTORS

Nacional
Chevrolet Suburban, C-K 1500, 2500 V-8 5.7 y 7.4L 86/03
GMC 1500 Sierra V-6 4.3L 96/03, S-15 Bravada V-6 4.3L 96/01
Americana
K, C 1500-2500 Suburban S-10 Blazer y Pick-up, Silverado
1500 LS, WT, 1500 Classic LS, Classic WT, WT S15 Jimmy,
Blazer, Trail, Blazer, Express 1500 Sonoma; Chevy, GMC
96/07; Isuzu 97/00; Olds 96/01
No. Original: 12557563

6257



GENERAL MOTORS

Nacional y Americana
Cavalier 2.2 4 Cil. 95/04
No. Original: 24574528

6258



GENERAL MOTORS

Nacional y Americana
Kit cuerpo de aceleración
Toma de agua Cavalier 6 Cil 90/94
No. Original: 17111959

6259



GENERAL MOTORS

Nacional y Americana
Cavalier y Pontiac Sunfire
2.2L 4 Cil. 98/02
No. Original: 24575474

6260



GENERAL MOTORS

Nacional
SIN TERMOSTATO
Pick-up 1500, 2500 03/07 Express Van 03/08, Trail Blazer
02/08, Camion 97/02 Corvette 97/04
Americana
Cadillac escalada V8 03, Corvette 03/97, Express
2500, Silverado 1500 V8 03, Silverado 1500 HD, 2500 HD
V8 6.0 03/99, Silverado 3500, Sierra 3500 01/03, SSR V8
03, Tahoe 00/03, Trailblazer 03, Sierra 2500, 3500 03,
Sierra Denali y Yukon V8 6.0 01/03, Camaro V8 5.7 98/02,
Suburban 1500 V8 5.3 01/02, 2500 6.0 01/02, Firebird V8
5.7 98/02, Sierra C3 V8 6.0 20/01, Chevy 98/05; GMC
99/05; Hummer 03 No. Original: 12571261

6260-T



GENERAL MOTORS

CON TERMOSTATO

6261



GENERAL MOTORS

Nacional y Americana
Camionetas y Pick up GM
99/05, Avalanche, Suburban,
Escalada, Sonora, Sierra,
Yukon, 2500 y 3500 Motores 5.3L V8 99/05
No. Original: 12600172

6262



GENERAL MOTORS

Nacional
Malibu motor 6 Cil. 2.4L 96/02
Americana
Malibu 96/02; Cavalier 00/02; Alero y Grand Am 00/01
Sunfire 00/02 4Cil. 2.4L
Buick 96/98; Chevy y Pontiac 96/02; Olds 96/01
No. Original: 24575259

6263



GENERAL MOTORS

Nacional y Americana
Cavalier 95/02
Pontiac Sunfire 4 Cil. 95/05
Buick, Olds y Pontiac 94/95 Chevy 94
No. Original: 24573020

6264

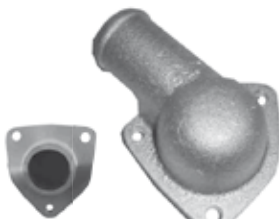

GENERAL MOTORS

Americana
Chevrolet Cavalier 97/98
Pontiac Sunfire 96/98 4Cil. 2.2L
Chevy 96/97
No. Original: 24575189

6265



GENERAL MOTORS

Nacional
Sonoma, S10 Pick up L4 2.2L
98/03; S15 Pick up L4 2.2L 03/98
Americana
S10 Pick-up y S15 Sonoma
2.2L 4 Cil. 94/03
Chevy y GMC 98/03 Isuzu 98/00
No. Original: 24576531

6266



GENERAL MOTORS

Nacional
Uplander 05-09 Venture 97-05 Pontiac Actec 01-05 Impala 00-05
Americana
Buick Century 03 3.1L V6 Century Custom 00-05 3.1L V6
Century Limited 00-05 3.1L V6 Century Special
Edition 05 3.1L V6 Rendez Vous 02-05 3.4L 5L V6
Rendez Vous CXL 06-07 3.4L V6 Tempra CX 05-06
V6 Chevrolet Impala 05-06 3.4L V6 Lumina 01-01 3.1L V6
Monte Carlo LS 00-05 3.4L V6 Uplander
LS LT 05 05.3L V6 Ventana 00-04 3.4L V6 Ventana LS, LT,
PLUS 05 3.4L V6 Oldsmobile Silhouette 03-
04 3.4L V6 Pontiac Actec 01-05 3.4L V6 Aztec 01 3.4L V6
Aztec Rally 04 3.4L V6 Grand Prix 00-05 3.1L V6
Montana 00-05 3.4L V6 Montana SV6 05-06 3.5L V6 Saturn Relay 2, 3 05-06 3.5L V6
No. Original: 10182644

6267



GENERAL MOTORS

Nacional
Blazer S10 60 95/99
Americana
Chevrolet Astro 1990-94 V6 4.3L C1500-2500 Pick up 1992-96 V6 4.3L
G10/G20/VAN 1992-95 V6 4.3L, K1500-2500 Pick up 1992-96 V6 4.3L P30
VAN 1991-95 V6 4.3L S10 Blazer y Pick up 1991-95 V6 4.3L GMC C1500-
2500 Pick up 1992-95 V6 4.3L G15/G1500, G25/G2500,
G35/G3500 VAN 92-95 V6 4.3L K1500-2500 Pick up
1992-95 V6 4.3L P3500 VAN 1991-95 V6 4.3L S15
Jimmy 1991-94 V6 4.3L S15 Sonoma 1991-95 V6 4.3L
Safari 1990-94 V6 4.3L Oldsmobile Bravada 1991-92 V6 4.3L
No. Original: 10172261

6268



GENERAL MOTORS

Nacional
Express Van 03/08, Blazer 60 95-99 Heavy Duty 97/04
Americana
Chevrolet Astro 96-05 V6 4.3L C1500 Pick-up 97-98
V6 4.3L Express 1500-2500 00-06 V6 4.3L G10 Van 98-98 V6 4.3L
G20 Van 1995 V6 4.3L K1500 Pick-up 97-98 V6 4.3L
P30 Van 98-99 V6 y V8 4.3 y 5.7L GMC C1500 Pick-up
97-98 V6 4.3L G15/G1500, G25/G2500 Van 98-98 V6 4.3L
K1500 Pick-up 97-98 V6 4.3L P3500 Van 1999 V6 y
V8 4.3 y 5.7L P3500 Van 98-98 V6 y V8 4.3 y 5.7L
Safari 96-05 V-8 4.3L Savana 1500-2500 99-05 V-8 4.3L
No. Original: 12556953

6269



GENERAL MOTORS

Nacional
Express Van 97/02 Pick up 99/02 Heavy Duty RC
Americana
Cadillac Escalade 98-00 V8 5.7L Chevrolet C1500-2500 Pick-up 00 V8 5.7L
Suburban 96-00 V8 5.0 y 5.7L C3500 Pick-up 96-00 V8 5.7L
Express 1500-2500-3500 99-02 V8 5.0 y 5.7L G10-20-30 Van 96-98 V8 5.0 y 5.7L
K1500-2500 Pick-up 00 V8 5.7L Suburban 96-98 V8
5.0 y 5.7L K3500 Pick-up 96-00 V8 5.7L Tahoe 96-00 V8 5.7L
GMC C1500-2500-3500 Pick-up 96-00 V8 5.0 y 5.7L
G25/G2500, G35/G3500 Van 98-98 V8 5.7L K1500-2500 Pick-up 00 V8 5.7L
Suburban 96-00 V8 5.0 y 5.7L K3500 Pick-up 96-00 V8 5.7L
Savana 1500-2500-3500 99-02 V8 5.0 y 5.7L Yukon 96-00 V8 5.7L
No. Original: 12556954

6270



GENERAL MOTORS

Americana
Buick todos, Oldsmobile,
Pontiac, Boneville 3.8L 6 Cil '88
No. Original: 25532950

TOMAS DE AGUA Water Outlet



<p>6270-T</p>  <p>GENERAL MOTORS CON TERMOSTATO</p>	<p>6271</p>  <p>GENERAL MOTORS Nacional SIN TERMOSTATO Cadillac Catera V6 3.0L 97/01 Saab 9-5, 900 SE V6 3.0L 99/01, Saturn L series V6 3.0L 02/04 Americana Cadillac CTS v6 3.2 01/05, Saab 900 y 9000 V6 2.5 94/97 y 96/97 No. Original: 9129999</p>	<p>6271-T</p>  <p>GENERAL MOTORS CON TERMOSTATO</p>	<p>6272</p>  <p>GENERAL MOTORS Nacional y Americana SIN TERMOSTATO Saturn SC, SL y SW L4 1.9L 91/02 No. Original: 21006065</p>
<p>6272-T</p>  <p>GENERAL MOTORS CON TERMOSTATO</p>	<p>6273</p>  <p>GENERAL MOTORS Americana Chevrolet Bel Air 66/73, Biscayne 66/72, Camaro 67/73, Caprice 66/72, Caprice Classic y Estate 73, Chevelle 66/72, Deluxe 68/69, Concours 68/72, Greenbriar 69/72, Malibu y Nomad 68/72, Chevy II 66/67, El Camino y Corvette 66/73, Camino Custom 69/73, Impala 66/73, Kingswood 69/72, Malibu, Nova 66/73, Malibu Estate 73, Sprint 71/73, Sprint Custom 72/73, Chevy 66/73, GMC 71/73 No. Original: 3877660 y 3896958</p>	<p>6274</p>  <p>GENERAL MOTORS Nacional CON TERMOSTATO Vectra 4 Cil 2.0 Y 2.2L 8-V 94/04 No. Original: 90410665</p>	<p>6275</p>  <p>GENERAL MOTORS Nacional y Americana CON TERMOSTATO Astra GLS 4 Cil 1.8 Y 2.0L 8-V 91/98 No. Original: 90352677</p>
<p>6276</p>  <p>GENERAL MOTORS Nacional y Americana CON TERMOSTATO Astra, Vectra 4 Cil 2.2 Y 2.4L 16V 04/06 No. Original: 90501699</p>	<p>6277</p>  <p>GENERAL MOTORS Nacional y Americana CON SENSOR Astra, Zafira y Vectra 4 Cil. 1.8L 01/07 y 2.0L 04/06 No. Original: 24456401</p>	<p>6278</p>  <p>GENERAL MOTORS Nacional Aveo 1.6L 4 Cil. 04/07 Americana Aveo LS 04/07; Aveo LT Special value 05/07, Lanos 00/02 4 Cil. 1.6L No. Original: 96282726</p>	<p>6279</p>  <p>GENERAL MOTORS Nacional Chevrolet C2500-3500, K2500-3500 Pick up V8 7.4L, Suburban C2500/ K2500, Van P30/P35/P3500 V8 7.4L 96/99, Pick up Sierra/KC C2500/K3500, K2500/3500 V8 7.4L 96/99 Americana C/K 2500 Pick up, C/K 3500 Pick up, Express 3500, C/K 2500 Pick up, c/k 3500 Pick up, Savana 3500 8 Cil. 7.4L No. Original: 10226490</p>
<p>6280</p>  <p>GENERAL MOTORS Nacional y Americana SIN TERMOSTATO Colorado L4 2.8L y L5 3.5L 04/05, Colorado LS 3.7L 07/08, Canyon L4 2.9L y L5 3.5L 07/09, Canyon L4 2.8L 04/06 y L5 3.7 07/08, Hummer H3 L5 3.7L 07/09 y 3.5L 2006</p>	<p>6281</p>  <p>GENERAL MOTORS Nacional Matiz 1.0L 4 Cil. 04/06 No. Original: 96317980</p>	<p>6282</p>  <p>GENERAL MOTORS Nacional Aveo 1.6L 4 Cil. 08/Up CON TERMOSTATO No. Original: 96407677</p>	<p>6283</p>  <p>GENERAL MOTORS Nacional Captiva 2.4L 4 Cil 08/11 No. Original: 12607291</p>

<p>6284</p>  <p>GENERAL MOTORS Nacional Captiva 3.2L 6 Cil. 2007 No. Original: 92067797</p>	<p>6285</p>  <p>GENERAL MOTORS Nacional Captiva 3.6L 6 Cil. 08/10 No. Original: 12607195</p>	<p>6286</p>  <p>GENERAL MOTORS Nacional Captiva 3L 6 Cil. 2011 No. Original: 12622596</p>	<p>6287</p>  <p>GENERAL MOTORS Nacional Optra 1.4L 4 Cil. 02/07 No. Original: 96460002</p>
<p>6288</p>  <p>GENERAL MOTORS Nacional Optra 1.6L 4 Cil 08/11 CON TERMOSTATO No. Original: 968352861</p>	<p>6289/Kit</p>  <p>GENERAL MOTORS Nacional Optra 1.8L 4Cil 07/11 (Toma de agua, housing, termostato y sensor) No. Original: 96414627</p>	<p>6290</p>  <p>GENERAL MOTORS Nacional Acadia 3.6L 6 Cil. 07/11 No. Original: 12591005</p>	<p>6291</p>  <p>GENERAL MOTORS Nacional Spark 2011 y Matiz 08/11 1.0L 4 Cil. 2011 CON TERMOSTATO No. Original: 96988257</p>
<p>6292</p>  <p>GENERAL MOTORS Nacional Chevrolet Camaro 3.4L 6 Cil. 93/02 No. Original: 10151656</p>	<p>6293</p>  <p>GENERAL MOTORS Nacional Lumina 95-99 6 Cil. 3.4L, Grand Prix 88-91 8 Cil. 5.0L, Monte Carlo 95/99 8 Cil. 5.0L Americana Chevrolet Lumina 91-95, Monte Carlo '95, Oldsmobile Cutlass Supreme 91-95, Pontiac Grand Prix 91-95 6 Cil. 3.4L; No. Original: 10162146</p>	<p>9251</p>  <p>HONDA Americana Honda Civic CVCC 1.5, Wagon, CRX C/A.T. Except . Hi Alt 84/88, Civic hatchback, CRX C/1332 cc 84/87 No. Original: 19311-PE2-000 y 19311-PE0-000</p>	<p>9253</p>  <p>HONDA Americana Honda Prelude, Accord 1.8y 2.0L 4 Cil 83/90 No. Original: 19311-PC6-000</p>
<p>9257</p>  <p>HONDA Americana Honda Accord, Civic CVCC 1.3 ,1.5 y 1.8L 4 Cil 76/84 Accord y Prelude 1.5L y 1.8L 4 Cil. 76/82 No. Original: 19311-PA6-000 19311-PA0-000</p>	<p>9258</p>  <p>HONDA Nacional SIN TERMOSTATO Civic SI L4 2.0L 03/07 CR-V L4 2.4L 03/07 Acura RSX L4 2.0L 02/06 Americana RDZ 2.3L 07/09; TSX 2.4L 04/09; CSX TYPE-S 2.0L 07/08; Civic MUGEN SI 2.0L 02/08; CR-V EX, EXL, LX 2.4; CSX PREMIUM, TOURING 06; RSX TYPE-S 2.0L 4 Cil. 02/06</p>	<p>9258-T</p>  <p>HONDA CON TERMOSTATO</p>	<p>9259</p>  <p>HONDA Nacional y Americana CON TERMOSTATO Honda Accord y Element 4 Cil. 2.4L L4 03/09 Acura TSX L4 2.4L 01/09</p>

<p>9261</p>  <p>HONDA Nacional y Americana Honda Accord 4 Cil 96/01 City y Fit 1.5L 4 Cil 09/12 Civic 1.8L 4 Cil 97/03 No. Original: 19311P08000</p>	<p>9262</p>  <p>HONDA Nacional Civic SI, CRV 07 4 Cil. 2.0L CON TERMOSTATO No. Original: 19301-RAF-003 19301-RAF-004</p>	<p>9501</p>  <p>HYUNDAI Nacional Atos Hyundai 1.1L 4 Cil. 01/04 Bulbo Americana Accent bulb 1.5L, 1.6L 4 Cil. 01/03 No. Original 25611 02502</p>	<p>9502</p>  <p>HYUNDAI Nacional Atos Hyundai 1.1L 4 Cil. 01/04 Termostato Americana Accent 1.5L, 1.6L 4 Cil 95/02 No. Original: 25632 02501</p>
<p>9503</p>  <p>HYUNDAI Nacional Atos Hyundai 1.1L 4 Cil. 01/04 Módulo housing (9502) Americana Accent housing 1.5L, 1.6L 4 Cil. 01/03 No. Original: 25622 02501</p>	<p>9504</p>  <p>HYUNDAI Nacional Atos Hyundai (sin defroster) 1.1L 4 Cil. 05/Up No. Original: 25622-02750</p>	<p>9505</p>  <p>HYUNDAI Nacional y Americana Atos Hyundai (con defroster) 1.1L 4 Cil. 05/Up No. Original: 25622-02551</p>	<p>9506</p>  <p>HYUNDAI Nacional y Americana Atos Hyundai 1.1L 4 Cil. 05/Up No. Original: 25611-02552</p>
<p>9507</p>  <p>HYUNDAI Nacional y Americana H100 Diesel (Ajustador de termostato) 4 Cil. 2.5 L Diesel 06/09 No. Original: 2512542600</p>	<p>9508</p>  <p>HYUNDAI Nacional y Americana Housing H100 Diesel 4 Cil. 2.5 L Diesel 06/09 No. Original: 2512742540</p>	<p>9509</p>  <p>HYUNDAI Nacional H100 Gasolina (Conector de salida de agua) 4 Cil. 2.4 L 03/05 No. Original: 2561142550</p>	<p>9138</p>  <p>ISUZU Y SUBARU Americana Isuzu Pick-up 1.8 y 2.0L Gas 81/87, Isuzu Trooper 2.3L 84/85, I-Mark 1.8L Gas 81/84 Chevy 75/81; Plymouth 89 No.Original: 94201665 94238380 y 8-94238-380-0</p>
<p>9269</p>  <p>ISUZU Y SUBARU Americana Subaru 2 Dr. todos, Except XT 85/89, Camionetas todas 85/87 Subaru todos 80/84 1.6 y 1.8L No. Original: 41754-7100</p>	<p>9401</p>  <p>ISUZU Y SUBARU Americana Subaru Baja 05-06, Forester '05, Impreza 04-05, Legacy '05, Outback '00 4 Cil. 2.5L No. Original: 11060-AA071</p>	<p>9137</p>  <p>MAZDA Americana Mazda Tribute DX 2.0 4 Cil. 01/02 No. Original: F5RZ-8592-A</p>	<p>9146</p>  <p>MAZDA Americana Mazda 3.0L 6 Cil. 94/01 No. Original: XL5Z-8592 AB</p>

TOMAS DE AGUA Water Outlet



18

<p>9147</p> 	<p>9148</p> 	<p>9149</p> 	<p>9150</p> 
<p>MAZDA Nacional Mazda Tribute 2.0L 4 Cil. 00/04 Aut. Importado No. original: XS4Z8592AC</p>	<p>MAZDA Nacional Mazda 2.0 y 2.4L 4 Cil. 97/02 Camioneta. Americana Mazda 91/97 No. Original: F0TZ-8592 CA</p>	<p>MAZDA Nacional CON SENSOR Y TERMOSTATO Mazda M-3, M-5, 2.0L 4 Cil. 03/Up No. Original: 1S7Z-8575-AG</p>	<p>MAZDA Nacional CON TERMOSTATO SIN SENSOR Mazda M-3, M-5, 2.0L 4 Cil. 03/Up No. Original: 3M4Z-8575-B</p>
<p>9198</p> 	<p>9199</p> 	<p>9260</p> 	<p>9268</p> 
<p>MAZDA Americana Mazda Pick-up series B 1000cc,1200cc, 1600cc 1800cc, 2000cc y 2200cc 4 Cil 72/82 No. Original: 0290-15-172A, 0290-151720</p>	<p>MAZDA Americana Housing Mazda Tribute 2.0L 4 Cil. 02/04 No. Original: YS4Z-8592-BD</p>	<p>MAZDA Americana Mazda Pick-up 81/85, Mazda 626 todos 79/82 No. Original: 0222-15-172B Ford E07Z-8592C</p>	<p>MAZDA Americana Mazda 626 todos Gas 2.0L 83/87 No. Original: F801-15-161</p>
<p>9176</p> 	<p>9179</p> 	<p>9203</p> 	<p>9204</p> 
<p>NISSAN Americana Nissan 510, 520, 521, 610, 620, 710 y 720 1595cc y 1770cc, 1.6 1.8L, 240Z y 260Z 2393cc y 2565cc 2.4 y 2.6L 6 Cil 68/74 No. Original: 11060-U2001 11060-U0100, 11060-21000</p>	<p>NISSAN Nacional Platina 1.6 4 Cil 03/Up Aprio 1.6L 4 Cil 08/Up Nylon Americana Platina 4 Cil 1.6L '03 No. Original: 7700101179</p>	<p>NISSAN Americana Nissan 810, Maxima LD28 2793cc LD28 79/84, Nissan 610, 620,720 y Pick-up 79/85 Except 81/82 720 L20B 1952cc, Nissan 200 SX L20B 1952cc, 2.0L, Nissan 510 L20B 74/82 No. Original: 11060-U6700 y 11060-Y7010</p>	<p>NISSAN Americana Nissan 810 y Maxima L24E 2393cc, 280Z y 280ZX L28E 2753cc 6 Cil.2.4 y 2.8L, 200SX C/Z20E 1952cc 4 Cil 2.0 y 2.2L 77/84 No. Original: 11060-P6500 y 11060-N4200</p>
<p>9207</p> 	<p>9241</p> 	<p>9249</p> 	<p>9250</p> 
<p>NISSAN Americana 200SX C/Z20E 1952cc 2.0 y 2.2L200SX 4 Cil C/Z22E 2187cc 80/83 No. Original: 11060-N8400</p>	<p>NISSAN Americana Nissan Pathfinder 87/89, Stanza C/CA20S y CA20E 82/89, Nissan todos M10 Van 85/86 200SX C/CA20E 1.8 Turbo 84/89, Pick-up todas 2.4L 83/89 No. Original: 11060-W7001</p>	<p>NISSAN Americana Nissan 720, 820 Pick-up Pathfinder c/Gas Z20, Z22 Z24 4 Cil 79/86 No. Original: 11060-W7000</p>	<p>NISSAN Nacional Tsuru I, II y III 8 valvulas 84/92 Motor E-1500, 1600 84/up Americano Nissan Pulsar 1.6L, Sentra 1.5 y 1.6L 4 Cil. 83/88 No. Original: 11060-01M00</p>

<p>9307</p>  <p>NISSAN Nacional Tsuru III frontal modelo inclinada 92/Up Sentra 16V STD/AUTOM 95/00 Americana Tsuru 4 Cil. 1.6L '92 No. Original: 13049-F4300</p>	<p>9308</p>  <p>NISSAN Nacional D21 2.4 camioneta 4 Cil 94/Up Americana Frontier, Xterra 4 Cil 2.4L 98/04 No. Original: 13049-F4001</p>	<p>9309</p>  <p>NISSAN Americana Datsun 4 Cil 68/74, 240Z, 260Z 224, 610, 620, Z-24, Z-200 4 Cil. 2.0 y 2.4L 80/88 INFERIOR Diam. 0.642 milésimas de pulgada) No. Original: 13049-U0100</p>	<p>9310</p>  <p>NISSAN Americana Z-24, Z-200 4 Cil 2.0 y 2.4L 80/88, SUPERIOR (Diam. 0.738 milésimas de pulgada) No. Original: 13049 -U6701</p>
<p>9311</p>  <p>NISSAN Nacional y Americana Datsun y Nissan Motor J 1600 y 1800 Sedán, Sakura, Samurai, Pick-up e Ichi-van 69/Up No. Original: 11060-B2501</p>	<p>9312</p>  <p>NISSAN Nacional y Americana Tsuru I,II,III, Sentra 96/Up Motor 16 valvulas 94/01 E-1500, 1600 No. Original: 11060-53Y00</p>	<p>9314</p>  <p>NISSAN Nacional Tsubame y Tsuru III 16V Trans. STD 93/98 Americana Tsubame 4 Cil. 1.3L 94/98 No. Original: 13049 - F4100</p>	<p>9315</p>  <p>NISSAN Nacional Tsuru III 16V STD/AUTOM 93/06, Tsubame Trans. automática 94/99 Americana Pulsar NX 89/90 4 Cil. 1.6 Sentra 89/90 4 Cil. 1.6 No. Original: 13049 - F4105</p>
<p>9316</p>  <p>NISSAN Nacional y Americana Urvan 2.4 4 Cil 16V 99/01 No. Original: 13049-VJ260</p>	<p>9317</p>  <p>NISSAN Nacional y Americana Housing Tsuru III y Tsubame 4 Cil 16V 1.3L 92/07 Nissan 311-1T (Aplica para t.a. 9307 13049F4300) No. Original: 11061F4300</p>	<p>9318</p>  <p>NISSAN Nacional y Americana Housing Tsuru III y Tsubame 4 Cil 16V 1.3L 94/99 Nissan 321-2T (Aplica para t.a. 931513049F4100 y 931413049F4105) No. Original: 11061F4100</p>	<p>9319</p>  <p>NISSAN Nacional y Americana Urvan 2.4L 4 Cil. 16V 02/08 No. Original: 13049-VW100</p>
<p>9320</p>  <p>NISSAN Nacional y Americana SIN TERMOSTATO Altima V6 3.5L 04/06 Máxima V6 6.5L 02/07 Murano V6 3.5L 02/07 Quest V6 3.5L 04/09 No. Original: 21200-8J10B</p>	<p>9320-T</p>  <p>NISSAN CON TERMOSTATO</p>	<p>9321</p>  <p>NISSAN Nacional SIN TERMOSTATO Máxima V6 3.0L 95/01 Infiniti 130 V6 3.0L 97/01 370Z 2.5L 4 Cil 05/11 Americana Máxima V6 3.0L 95/01 Infiniti 130 V6 3.0L 99/01 y Pathfinder V6 3.5 2001 No. Original: 13049-6P001</p>	<p>9321-T</p>  <p>NISSAN CON TERMOSTATO</p>

TOMAS DE AGUA Water Outlet



















<p>9322</p> 	<p>9322-T</p> 	<p>9323</p> 	<p>9324</p> 
<p>NISSAN Nacional SIN TERMOSTATO Nissan Frontier V6 4.0L 05/07, Pathfinder V6 3.5L 01/02 y 4.0L 05/07 Xterra V6 4.0L 05/07 Americana Infiniti V6 3.5 07/08, Frontier y Pathfinder 4.0 01 y 05 /08; Xterra S, SE, X 05/08; FX35 y G35 03/07; M35 Sport 06/07; Grand Touring 03/07 No. Original: 13049-45100</p>	<p>NISSAN CON TERMOSTATO</p>	<p>NISSAN Nacional y Americana Nissan Z24, Z200 2.0 y 2.4 L 4 Cil. 80/88 Para salida ancha (Diam. 1,000 milésimas de pulgada) No. Original: 13049-U6701</p>	<p>NISSAN Nacional Housing Tsuru I, II y III 8V 84/92 Motor E-1500, 1600 84/Up (Aplica para 9250) Americana Nissan Pulsar 1.6L, Sentra 1.5 y 1.6L 4 Cil. No. Original: 11061-01M15</p>
<p>9325</p> 	<p>9326</p> 	<p>9327</p> 	<p>9328</p> 
<p>NISSAN Nacional Altima mot. QR2SDE 2.5L 4 Cil 01/06 No. Original: 13049-3Z001</p>	<p>NISSAN Nacional Rouge mot. QR2SDE 2.5L 4 Cil. 06/11 No. Original: 13049-JA00A</p>	<p>NISSAN Nacional Tiida Sedán mot. QG18DE 1.8L 4 Cil y B16 mot. MR20DE 2.0L 4 Cil 07/10 No. Original: 13049-ET000</p>	<p>NISSAN Nacional Frontier mot. QR2SDE 2.5L 4 Cil 05/11 No. Original: 13049-EA000</p>
<p>9329</p> 	<p>9330</p> 	<p>9331</p> 	<p>9332</p> 
<p>NISSAN Toma de agua Pick up, Estaquitas 2.4 Lts 4 Cil 07/09 No. Original: 11060 F450A</p>	<p>NISSAN Housing Sentra 1.8 Lts 4 Cil 02/06 No. Original: 11061 F460B</p>	<p>NISSAN Housing Sentra 1.8 Lts 4 Cil 01/02 No. Original: 11060 4Z015</p>	<p>NISSAN Nacional Tsuru III 1.6L 4 Cil. 92/10 No. Original: 13049-53J00 13049-64Y00</p>
<p>9333</p> 	<p>9334</p> 	<p>9335</p> 	<p>9336</p> 
<p>NISSAN Nacional y Americana Toma de agua Nissan Quest 3.0L 92/98 No. Original: 11061-0B010</p>	<p>NISSAN Americana Nissan 200SX 87 6 Cil. 3.0L Nissan 300ZX 84-89 6 Cil. 3.0L Nissan Pathfinder 87 6 Cil. 3.0L Nissan D21 Pick up 86-84 6 Cil. 3.0L Nissan Frontier 99-04 6 Cil. 3.0L Nissan Pick up 95-96 6 Cil. 3.0L Nissan Xterra 00-04 6 Cil. 3.0L Infiniti M30 90-92 6 Cil. 3.0L Infiniti QX4 97-01 6 Cil. 3.0L No. Original: 13049-V5000</p>	<p>NISSAN Americana Toma de agua Infiniti Q45 90-96 8 Cil. 4.5L No. Original: 13049-60U00</p>	<p>NISSAN Nacional Housing Tsuru II 4 cil 1.6 litros 87/88 No. Original: 11061-01M12</p>

<p>9337</p> 	<p>4001</p> 	<p>4001-T</p> 	<p>4002</p> 
<p>NISSAN Nacional Housing Tsuru III 92-97 4 Cil. 1.6L No. Original: 11061-17M10</p>	<p>PEUGEOT Nacional y Americana Peugeot 304 1.4, 1.6 y 2.0L 16V 00/07, Peugeot 406 y 607 2.2L 16V 00/07 Peugeot 206 2.0L 16V 00/02, Peugeot 307 2.0 y 2.2L 16V 92/07 No. Original: 8714C-C1</p>	<p>PEUGEOT CON TERMOSTATO</p>	<p>PEUGEOT Nacional y Americana Peugeot 205 y 309 1.9L 4 Cil. 92/Up Peugeot 206 1.9L 98/Up No. Original: 9609493180</p>
<p>4401</p> 	<p>4402</p> 	<p>9143</p> 	<p>9144</p> 
<p>RENAULT Nacional y Americana CON SENSOR Y TERMOSTATO Renault Clio II, Kangoo, Megane II 1.6 4 Cil. DCI 02/07 No. Original: 8200267349</p>	<p>RENAULT Nacional Renault Clio 1.6 4 Cil 03/Up Nylon No. Original: 7700101179</p>	<p>TOYOTA Americana Toyota Celica, Corona, Corona Mark II, HiLux 8R, 8RC 1858cc, 19RC 1968cc 4 Cil 1.9, 2.0L 69/74 No. Original: 16331-33010</p>	<p>TOYOTA Americana Corolla 1600cc 70/79 Carina todos 71/73 No. Original: 16331-31010</p>
<p>9145</p> 	<p>9151</p> 	<p>9152</p> 	<p>9153</p> 
<p>TOYOTA Nacional Toyota Hilux 3Y, 4Y, 4-Runner 2.0L Y 2.2L 84/90 No. Original: 16661-71010</p>	<p>TOYOTA Nacional Corolla 93-97 4 Cil Americana Toyota Celica 94-97 y Corolla 93-97 4 Cil. 1.8L No. Original: 16321-15040</p>	<p>TOYOTA Nacional Paseo, Tercel 89-99 4 Cil Americana Toyota Paseo 92-98 4 Cil. 1.5L No. Original: 16321-10011</p>	<p>TOYOTA Nacional Paseo, Tercel 89-99 4 Cil Americana Toyota Paseo 92-98 4 Cil. 1.5L No. Original: 16321-11011</p>
<p>9154</p> 	<p>9155</p> 	<p>9156</p> 	<p>9157</p> 
<p>TOYOTA Nacional 4 runner, Tacoma 95-04 6 Cil Americana Toyota 4 runner 00 4 Cil 2.7L Toyota Tacoma 00-04 4 Cil 2.4 y 2.7L No. Original: 16321-0W010</p>	<p>TOYOTA Nacional Tercel 91-94 4 Cil No. Original: 16333-11160</p>	<p>TOYOTA Nacional Paseo, Tercel 91-99 4 Cil. No. Original: 16333-11200</p>	<p>TOYOTA Nacional 4runner Americana 89-95 6 Cil. Americana Toyota 4runner 88-95 6 Cil. 3.0L; *96 6 Cil. 3.4L, Pickup 89-95 6 Cil. 3.0L Toyota T100 93-94 6 Cil. 3.0L No. Original: 16321-65030</p>

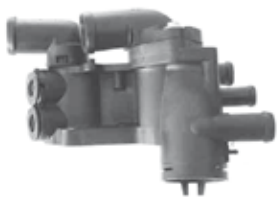
TOMAS DE AGUA Water Outlet

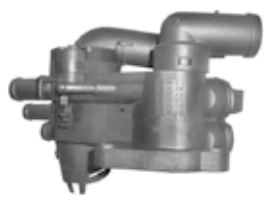

<p>9158</p>  <p>TOYOTA Nacional Corolla, Matrix, MR2 98-08 4 Cil Americana Toyota Celica 00-05; Corolla y Matrix 03-07; MR2 Spyder 00-05 4 Cil. 1.8L No. Original: 16321-22070</p>	<p>9159</p>  <p>TOYOTA Nacional Camry, Matrix, Solara 04-09 4 Cil. Americana Toyota Camry 05/07 4 Cil. 2.4L; Toyota Highlander '07 4 Cil. 2.4L; RAV4 07 4 Cil. 2.4L; Solara 06-07 4 Cil. 2.4L No. Original: 16321-0H011</p>	<p>9160</p>  <p>TOYOTA Nacional Sienna 04-10 6 Cil. Americana Lexus RX333 04-06 y Sienna 04-06 6 Cil. 3.3L No. Original: 16321-0A040</p>	<p>9175</p>  <p>TOYOTA Americana Celica 2189cc Corona Excep Mark II, HiLux 20R Pck-up Excep 4 Runner 2.2L 4 Cil 77/79 No. Original: 16331-38011</p>
<p>9193</p>  <p>TOYOTA Americana Toyota Celica, Corona, Hiluxw/20R, 2189CC. Motor de 8/79 a 8/70. 4 Cil. 80/81 No. Original: 16331-38012</p>	<p>9205</p>  <p>TOYOTA Americana Toyota Celica, Corona 22R 8/80, HiLux 22R 8/80 2366cc, Except California, 81/82 No. Original: 16331-35020 y 16331-35030</p>	<p>9273</p>  <p>TOYOTA Americana Toyota Cressida, Supra W/4ME y 5ME todos 79/81 No. Original: 16331-45030</p>	<p>9286</p>  <p>TOYOTA Americana Toyota 4 Runner w/EFI '84 Toyota Celica w/EFI 83/85 Toyota 4WD Pick-up & 4 Runner w/EFI '88 Toyota Pick-up w/EFI 84/87 Toyota Pick-up & 4 Runner w/EFI 89/90 4 Cil. 2.4L No. Original: 16331-35040</p>
<p>9289</p>  <p>TOYOTA Americana Toyota Cressida, Supra todos C/5MGE 2.8L 6 Cil 82/88 No. Original: 16331-43010</p>	<p>9293</p>  <p>TOYOTA Americana Toyota Corolla Coupe, SR5 4AC 2 Bbl 1.6L, Toyota Tercel 3A, AC Lower 1.5L 4 Cil 83/88 No. Original: 16323-15020</p>	<p>9306</p>  <p>TOYOTA Americana Toyota Van Todas 2.0 y 2.2L 4 Cil 84/90 No. Original: 16321-71010</p>	<p>8076</p>  <p>VAM-AMC Americana AMX Concorde 8 Cil. 5L 78/99, Gremlin Hornet 76 8 Cil. 5L, Matador 76 8 Cil 5.0L y 5.9L, Matador 78 i Cil. 5.9L, Pacer 68/79 8 Cil. 5L, Spirit 79 8 Cil 5L, Jeg CJS y CJ7 76/78 8Cil 5L No. Original: 3928220</p>
<p>8077</p>  <p>VAM-AMC Nacional Rambler 6 cil. Americana AMC todos 199 3.3L, 232 3.8L, 258 4.2L 68/80, Jeep todos 2.58 4.2L, 6 Cil. 68/88 No. Original: 3189718</p>	<p>8095</p>  <p>VAM-AMC Americana c/rosca All AMC, Except 360 California & 1976 401 Engine, All AMC, Except 360 California & 1976 401 Engine, All AMC, Except 360 California & 1976 401 Engine 67/80 All Jeep, All Jeep 70/79 8 Cil. No. Original 3210 852, 3228 220, 3179073</p>	<p>8105</p>  <p>VAM-AMC Americana All AMC, Except 360 California All AMC (3.8L) & (4.2L) 6 Cil All Jeep (3.8L) & (4.2L) 6 Cil AMC Engine 75/80 No. Original 3224 216</p>	<p>8106</p>  <p>VAM-AMC Americana Jeep todos Serie J 6 Cil 230 72/73 No. Original: 800293</p>

<p>8178</p>  <p>VAM-AMC Nacional y Americana AMC y Jeep todos 258 4.2L 151 2.5L 81/90, Jeep Cherokee Comanche, Wagonner 4.0L 89/90 Motor 282 Serie J No Original: 3235347 y 8134147</p>	<p>8179</p>  <p>VAM-AMC Americana sin rosca Jeep todos 304 5.0L, 360 5.9L V-8 80/93, Chevy y GMC 66 80/91 No. Original: 3238509</p>	<p>087</p>  <p>VOLKSWAGEN Nacional Repartidor de agua Jetta A4 1.8L 4 Cil 00/05 No. Original: 1J0121087</p>	<p>087-A</p>  <p>VOLKSWAGEN Nacional y Americana Repartidor de agua (con sensor) Golf, Jetta A4 4 Cil 99/03 Nylon No. Original: 1J0 121 087A</p>
<p>087-B</p>  <p>VOLKSWAGEN Nacional y Americana Repartidor de agua Golf, Jetta A4 1.4, 1.6, 2.3 y 1.9 4 Cil 99/03 Diesel (manual sin aire acondicionado) No. Original: 1J0 121 087B</p>	<p>087-C</p>  <p>VOLKSWAGEN Nacional y Americana Repartidor de agua Golf, Jetta A4 4 Cil 1.8 99/03 Nylon No. Original: 1J0 121 087C</p>	<p>087-D</p>  <p>VOLKSWAGEN Nacional Codo de agua VR6 Eurovan TDI 1.9L 6 Cil 06/09 No. Original: 1J0121087D</p>	<p>087-E-1</p>  <p>VOLKSWAGEN Nacional Beetle 00-07 4 Cil. 2.0L No. Original: 1C0 121 087</p>
<p>087-H</p>  <p>VOLKSWAGEN Nacional Codo de agua grande Bora 2.0L 4 Cil 05/09 No. Original: 1K0121087H</p>	<p>109-AQ</p>  <p>VOLKSWAGEN Nacional Codo de agua en forma de "Y" con manguera Golf y Jetta A4, Sharan, Audi turbo 1.8L 4 Cil 00/05 No. Original: 1J0122109AQ</p>	<p>111-AP</p>  <p>VOLKSWAGEN Nacional CON HOUSING Y CONECTOR Polo 4 Cil. 1.4L 02/08 Seat Ibiza No. Original: 03212111AP</p>	<p>111-B</p>  <p>VOLKSWAGEN Nacional Gol 1.8 Y 2.0L 4 Cil. 99/Up para sensor superior. Cross Fox tod. mod. para sensor inferior Sportvan 1.6L 4 Cil 06/Up Saveiro 1.6L 4 Cil. 10/Up SIN SALIDA No. Original: 032 121 111B, 032 121 111BJ 032 121 111CK</p>
<p>111-CL</p>  <p>VOLKSWAGEN Nacional Polo 2.0 4 Cil. 01/06 Cross Fox 1.6L 4 Cil 05/Up CON SALIDA No. Original: 032 121 111CL</p>	<p>111-N</p>  <p>VOLKSWAGEN Nacional Golf IV 97/05 Golf IV, Variant 99/06, Lupo 98/05, Polo 94/99, Vento 95/98 Polo Classic 95/01, 4 Cil. Americana Caddy II 95/04, Polo classic ALM 1.6 97/02 otto AER 1.0 77/99 No. Original: 032-121-111N</p>	<p>117-A</p>  <p>VOLKSWAGEN Nacional Housing Corrado 2.9L VR6 92/95 Golf/Jetta 2.8L VR6 93/98 Passat 2.8L VR6 92/97 Eurovan 2.8L VR6 96/01 6 Cil. No. Original: 021121117A</p>	<p>117-C</p>  <p>VOLKSWAGEN Nacional Polo 1.6L 4 Cil. 87/94 Americana Golf, Jetta 87/94 No. Original: 030 121 117C</p>

<p>117-D</p> 	<p>117-E</p> 	<p>117-M</p> 	<p>117-N</p> 
<p>VOLKSWAGEN Nacional Golf, Jetta A2 1.8L 4 Cil. 83/92 Americana Golf y Jetta HZ, MH, NV, 2C 86/97, Polo HZ, MH, NV, 2G, AAK 82/90 No. Original: 030-121-117D</p>	<p>VOLKSWAGEN Nacional Housing VR6 Jetta A4 2.8L 6 Cil 00/04 No. Original: 022121117C</p>	<p>VOLKSWAGEN Nacional VW Polo 1.6L 4 Cil. 85/94 Americana Golf, Jetta 91/94 No. Original: 030 121 117M</p>	<p>VOLKSWAGEN Nacional Golf III 1.4 y 1.6L 91-99 Vento 1.4 y 1.6L 91/98 Seat Cordoba 1.4 y 1.6L 4 Cil. 93/99 No. Original: 030 121 117N</p>
<p>118-D</p> 	<p>120</p> 	<p>121</p> 	<p>121-A</p> 
<p>VOLKSWAGEN Nacional Polo 1.4L 4 Cil. 02/08 No. Original: 03212118D</p>	<p>VOLKSWAGEN Nacional A3, Derby 4 Cil. 1.8L 93/99 No. Original: 037-121-121A</p>	<p>VOLKSWAGEN Nacional y Americana Frontal VW Golf, Jetta A-4, Beetle 4 Cil. 2.0L 98/Up Nylon No. Original: 038 121 121</p>	<p>VOLKSWAGEN Nacional y Americana Jetta A3, Passat VR6 2.8L 6 Cil. 93/99, Golf 95/00, Eurovan 99/00 Nylon No. Original: 021 121 121 A</p>
<p>121-B</p> 	<p>121-C</p> 	<p>121-D</p> 	<p>121-E</p> 
<p>VOLKSWAGEN Nacional Pointer 1.6 y 1.8L 4 Cil 98/Uup No. Original 026-121-121A</p>	<p>VOLKSWAGEN Nacional Codo bomba de agua A4, New Beetle y Polo 2.0 00/Up Americana NB, Golf, Golf GTI 4cil. 1.8 y 2L 01/06, NB Turbo S 4cil. 1.8 00/04, Golf GL y GLS 4cil. 2.0, Golf Jetta 4cil. 1.8 y 2L 04/05, Jetta GLS 4cil. 1.8 y 2L 00/04, Passat y Touarg V6 3.6L 06/07 No. Original 06A 121 121 C</p>	<p>VOLKSWAGEN Nacional Passat 97/00 A3-T2A (codo de bomba de agua) Americana Passat 98/01 1.8L 4 Cil Audi, A4, Quattro 97/01 1.8L 4 Cil. No Original: 030 121 121 B</p>	<p>VOLKSWAGEN Nacional Golf, Jetta A4 99/06 New Beetle 99/06, Sharan 02/Up, Audi A3 96/01 Americana New Beetle BSW, BEW 98/06, Bora BKC, BXE, Golf, AJM, AVY, ATD 99/07, Jetta AXR 02/08, Variant 01/09, Sharan AWW, AVY, ASZ, BTB, Eurovan AXB, AXC, BRR, BRS 1.9 Audi A3 BKC, BXE 1.9 No. Original: 038 121 121 D</p>
<p>121-F</p> 	<p>121-G</p> 	<p>121-H</p> 	<p>121-J</p> 
<p>VOLKSWAGEN Nacional Codo bomba Agua VW Todos 1.6, 1.8 ENF/AGUA Americana Codo Bomba de Agua Jetta, Rabbit, Pick-up Rabbit, Qtum, Scirocco 1.5, 1.6, 1.7 y 1.8L 80/83 Audi 81/90; VW 75/93 No Original: 055-121-1211, 055-121-121A y 059-121-121</p>	<p>VOLKSWAGEN Nacional Eurovan T4 5 CIL 2.5L 91/03 No. Original: 074 121 121B</p>	<p>VOLKSWAGEN Nacional Golf III 1.6L 92/98 Polo 1.6L 4 Cil. 95/01 Americana Golf, Polo Vento No. Original: 032 121 121A</p>	<p>VOLKSWAGEN Nacional Bora 00/05, Golf A4 y Lupo 98/05, Polo 4 Cil. 03/05 Americana Golf AHW, AKQ, APE, AT, AUS, AXP 1.4 16V 99/01, Variant AHW, AZD, 1.4 1.6 16V 01/05, Polo Classic ADD, ADC 1.8 97/02 No. Original: 032 121 121J</p>



121-K

VOLKSWAGEN
Nacional
Polo 1.4L 4 Cil. 02/08
Seat, Ibiza
Americana
Polo 1.4L 4 Cil. 02/08
No. Original: 032121121K



131

VOLKSWAGEN
Nacional
Golf, Jetta 1.8L 4 Cil. 88/90 sin aire acondicionado
Americana
Golf, Jetta TDI PF, RV 98/92,
Passat ST TDI 88/93, Pointer TDI BGG 94/06,
Eurovan ABL 00/04
No. Original: 068 121 132



132

VOLKSWAGEN
Nacional y Americana
Golf, Jetta A4, Seat Leon,
Toledo 2.0L 4 Cil. 99/04
Nylon
No. Original: 06A-121-132



132-A

VOLKSWAGEN
Nacional
Passat 96/00, Audi A4 1.6L 4 Cil. 95/00
Americana
Passat 4/motion AHL, ARM,
APV 1.6 97/00, Audi, A4 AHL 1.6 95/99
No. Original: 050 121 132A



132-B

VOLKSWAGEN
Nacional
Golf, Jetta,
Combi y Corsar 3 bulbos
1.8L 4 Cil. 84/93
Americana
Rabbit 4 Cil. 1.8L 84/93 Nylon
No. Original: 037 121 132B



132-C

VOLKSWAGEN
Nacional
Bora 98/05, Golf IV 97/06, Polo 96/01, Audi A3 96/01,
Seat Cordoba, Ibiza 99/02,
León 99/06, Transporter 1.9L 4 Cil 05/09 y 5 Cil. 00/04
Americana
Audi, A3 97/03, Eurovan 03/10, New
Beetle TDI 98/05, Sport Van 1.9 06,
Derby, Golf y Jetta TDI 99/06
No. Original: 038 121 132C



132-D

VOLKSWAGEN
Nacional y Americana
Jetta A4 turbo 4 Cil. 1.8L 98/Up,
Seat Leon, Toledo 99/06 Nylon
Trans. STD y Automatico
No. Original: 06A 121 132 D



132-E

VOLKSWAGEN
Nacional
Eurovan-Panel 2.4 y 2.5L
5 Cil. 00/07 (gas y diesel)
Trans. manual. (2 bulbos, 1 salida)
Americana
Transporter T4 91/98 y LT 97/01 5 Cil. 2.8L
No. Original: 074-121-132



132-F

VOLKSWAGEN
Nacional
Passat (3B2) 00/07
Audi A4 (8d2, B5) 1.6L 4 Cil. 00/07
Americana
Passat AUG 1.8 98/01, Audi
A4 AWT 1.8 99/01, Audi A6 APV, AEB, AWT 1.8 98/01
No. Original: 058 121 132 A y 058 121 132 B



132-G

VOLKSWAGEN
Nacional y Americana
New Betlee 2.0L, Jetta 2.0L,
Golf Motor AEG 4 Cil. 01/10
Beetle 2.0L 4 Cil 00/05
No. Original: 06A 121 132C



132-H

VOLKSWAGEN
Nacional y Americana
Polo 98/05, Lupo 94/99 1.6L
4 Cil.
No. Original: 028-121-132C



132-I

VOLKSWAGEN
Nacional y Americana
Eurovan 2.4 Y 2.5L 4 Cil y
5 Cil. 90/03
No. Original: 074 121 132B



132-J

VOLKSWAGEN
Nacional y Americana
Golf 04/09, Jetta 06/08,
Passat 06/10, Polo 05/10,
Touran 03/10 4 Cil. 1.6L
No. Original: 038121132G



132-K

VOLKSWAGEN
Nacional
Seat Ibiza 4 Cil 2.0 L 00/05
No. Original: 050 121 132 B









132-P

VOLKSWAGEN
Nacional
Seat y Jetta A4 1.8L
4 Cil 00/05
No. Original: 06A121132P



133

VOLKSWAGEN
Nacional
Caribe Atlantic 1800
Golf, Jetta 87/90
Golf, Jetta 1.8L 4 Cil. 93/99
Americana
Golf, Jetta 87/90 4 Cil 1.8L
No. Original: 026 121 133D

<p>133-1</p> 	<p>133-A</p> 	<p>133-AB</p> 	<p>133-AH</p> 
<p>VOLKSWAGEN Nacional Pointer 1.8L 4 Cil. 97/05 Pointer city y Mi Derby Van 91/08 Americana Pointer 1.8L 4 Cil. 97/05 No. Original: 126-121-133.1</p>	<p>VOLKSWAGEN Nacional y Americana Golf 82/93, Audi 80 84/86, Audi Coupe 1.8L 4 Cil. 84/88 No. Original: 027121133 y 027121133A</p>	<p>VOLKSWAGEN Nacional y Americana Frontal VW Golf, Jetta 1.8L 4 Cil. 88/90 sin aire acondicionado Nylon No. Original: 068 121 133 AB</p>	<p>VOLKSWAGEN Nacional y Americana Golf GTI 02/06, Jetta 04/05, Jetta GLS 02/03, Audi TT 2.0L 4 Cil. 03/06 No. Original: 06A121133AH</p>
<p>133-B</p> 	<p>133-BC</p> 	<p>133-BL</p> 	<p>133-C</p> 
<p>VOLKSWAGEN Nacional Jetta A2 (2 bulbos, 2 salidas) 4 Cil 1.8L. 87/92 No. Original: 037 121 133B</p>	<p>VOLKSWAGEN Nacional Passat 1.8L 4Cil -/02 (Base corta 8 cm) No. Original: 06B121133D</p>	<p>VOLKSWAGEN Nacional Passat 1.8L 4 Cil 03/Up (Base larga 9 cm) No. Original: 06B121133D</p>	<p>VOLKSWAGEN Nacional y Americana Passat 2.0L 4 Cil. 88/99 No. Original: 037-121-133C</p>
<p>133-D</p> 	<p>133-E</p> 	<p>133-E/F</p> 	<p>133-G</p> 
<p>VOLKSWAGEN Nacional y Americana A3 Golf-Jetta 93/99 VR6 (triangular) 1.8L 4 Cil. No. Original: 021 121 133D</p>	<p>VOLKSWAGEN Nacional Passat 96/00, Audi A4 95/00, A4 Avant 96/01, A6 97/05 1.8L 4 Cil. Americana Audi 200 ANZ 1.8 96/99 No. Original: 058 121 133B</p>	<p>VOLKSWAGEN Nacional y Americana Frontal VW Golf, Jetta 1.8L 88/93 4 Cil. c/peine Nylon. No. Original: 037 121 133 E/F</p>	<p>VOLKSWAGEN Nacional Golf A4 98/05, Audi A3 96/01, Audi TT 98/Up 1.8L 4 Cil. Americana New Beetle AEG, APK, AZG, AZJ, AQY 2.0L98/06, New Beetle Cabrio AZJ, BEV 03/06 4 Cil. 2.0L No. Original: 06A 121 133C y 06A 121 132A</p>
<p>133-H</p> 	<p>133-I-1</p> 	<p>133-M</p> 	<p>143-D</p> 
<p>VOLKSWAGEN Nacional Jetta A4 turbo 1.8L 4Cil 03/Up No. Original: 06A121133BC</p>	<p>VOLKSWAGEN Nacional Sharan 02-07 4 Cil. 1.8L No. Original: 06A 121 133 5</p>	<p>VOLKSWAGEN Nacional y Americana Caribe 79/86, Combi 79/92 Golf 88/90 1600 4 Cil. 1.6L No. Original: 068121133M</p>	<p>VOLKSWAGEN Nacional y Americana Eurovan T4 2.4 Y 2.5 Motor AAB, ACU Y AAN 93/97 4 Cil y 5 Cil. No. Original: 074 121 143D</p>

<p>144</p>  <p>VOLKSWAGEN Nacional y Americana Golf, Jetta A2, A3 c/bulbo FBU c/aire Derby y Pointer 95/Up 4 Cil. 1.7 y 1.8L No. Original 068 121 144</p>	<p>144-B</p>  <p>VOLKSWAGEN Nacional y Americana A2-A3 4 Cil. 1.8 87/99 2 salidas Nylon No. Original: 026-121-144B</p>	<p>144-C</p>  <p>VOLKSWAGEN Nacional Bora 04/06, Golf Jetta A4 99/06, Eurovan Panel 00/06 Americana AAC, ABL 4 y 5 cil., Bora TDI 1.9, Golf R32 autom. ASZ 03/04, Jetta Variant Auto ASZ y moto 1.9 01/05 No. Original: 044-121-144B</p>	<p>144-H</p>  <p>VOLKSWAGEN Nacional A3 93/99 Derby 93/98 4 Cil. 2.0L Trans. manual (2 bulbos, 2 salidas) Americana Derby 4 Cil. 2.0L 93/98; Cabrio 95/02; Golf 93/02; Jetta 93/00 No. Original: 037-121-144H</p>
<p>144-J</p>  <p>VOLKSWAGEN Nacional y Americana Frontal VW Golf, Jetta 2.0L, c/aire 93/99 4 Cil Cabrio 95/02 Nylon No. Original: 037 121 144-J</p>	<p>145</p>  <p>VOLKSWAGEN Nacional y Americana Golf, Jetta 1800 88/Up 4 Cil. Aluminio No. Original: 026 121 145-E</p>	<p>145-2</p>  <p>VOLKSWAGEN Nacional y Americana Pointer cabeza sin bulbo 1.8L 94/08 4 Cil. Aluminio No. Original: 026-121-1452</p>	<p>145-2A</p>  <p>VOLKSWAGEN Nacional y Americana Pointer cabeza con bulbo 1.8L 94/08 4 Cil. Aluminio No. Original: 026-121-1452</p>
<p>145-A</p>  <p>VOLKSWAGEN Nacional Golf, Jetta 1800 88/Up 4 Cil, Caribe y Atlantico 75/86 c/aire Americana Golf, Jetta A2, A3 1.8L 84/93 No. Original: 026 121 145-F</p>	<p>145-B</p>  <p>VOLKSWAGEN Nacional Passat (3B6) 00/05 Audi 80 90/91 Audi 80 (8C, B4) 91/94 4 Cil. Americana Audi, Cabrio 2.0 A6, ABK 92/00 No. Original: 048 121 145B</p>	<p>145-C</p>  <p>VOLKSWAGEN Nacional Bora 98/05, Golf III 93/99, Polo 95/01, Audi A3 96/01, Seat Cordoba, Ibiza 96/02, Leon y Toledo 99/02 2.5L 6 Cil. No. Original: 028121145B</p>	<p>145-D</p>  <p>VOLKSWAGEN Nacional Eurovan pasajeros motor AVT 2.5L 5 Cil. 00/04 y Cargo 2.5L 4 Cil 05/09 No. Original: 074 121 145 B</p>
<p>145-P</p>  <p>VOLKSWAGEN Nacional Golf, Jetta 1800 88/Up 4 Cil. Nylon Americana Golf, Jetta A2, A3 1.8L 4 Cil. 84/93 No. Original: 026 121 145-E</p>	<p>291-AE</p>  <p>VOLKSWAGEN Nacional y Americana Golf, New Beetle, Passat, Bora, Jetta, Audi A3 1.8L 4 Cil. 99/Up Seat Toledo y León No. Original: 1K0122291AE</p>	<p>291-B</p>  <p>VOLKSWAGEN Nacional y Americana A4 (cople) New Beetle 2.5L 6 Cil. 99/Up incluye seguro No. Original: 1J0-122-291B</p>	<p>291-C</p>  <p>VOLKSWAGEN Nacional Cople de calefacción recto Jetta A4 2.0L 4 Cil.00/06 No. Original: 3B0122291B</p>

			
<p>291-D</p> <p>VOLKSWAGEN Nacional y Americana Cople A4 New Beetle Sharan 1.8L 4 Cil. 99/Up turbo con seguro No. Original: 1J0-122-291D</p>	<p>291-E</p> <p>VOLKSWAGEN Nacional Bora 2.5L 6 Cil. 02/Up No. Original: 6Q0122291E</p>	<p>291-F</p> <p>VOLKSWAGEN Nacional Cople A4 1.8L 4 Cil. New Beetle 99/Up manguera inferior radiador. No. Original: 6Q0122291F</p>	<p>291-G</p> <p>VOLKSWAGEN Nacional Polo Motor BBX 04-07 2.0L 4 Cil. No. Original: 1J0 122 291F</p>
			
<p>291-R</p> <p>VOLKSWAGEN Nacional Cople de calefacción Bora 2.5L 5 Cil. 05/09 No. Original: 1K0122291R</p>	<p>373-F</p> <p>VOLKSWAGEN Nacional Cople de calefacción con manguera Passat 2.8L 6 Cil 02/04 No. Original: 8D0819373AF</p>	<p>438-A</p> <p>VOLKSWAGEN Nacional Codo de agua Polo, Seat e Ibiza 2.0L 4 Cil 03/06 No. Original: 6Q0121438A</p>	<p>438-C</p> <p>VOLKSWAGEN Nacional Codo de agua Beetle turbo 1.8L 4 Cil 00/05 No. Original: 1C0121438A</p>
			
<p>619</p> <p>VOLKSWAGEN Nacional Golf Jetta A3 93/98, Golf A4 Cabriolet 99/06, Polo 03/06 4 Cil. Americana Derby ADD, ADC, ABA, 1.8 95/97, Golf 1.8 93/99, Golf Cabrio ADC, ABA 2.0 96/02, Jetta 1.8 93/99 No. Original: 037 121 619</p>	<p>1087-LG</p> <p>VOLKSWAGEN Nacional Repartidor de agua Bora 2.5L 6 Cil. 02/Up No. Original: 1K0121087LG</p>	<p>111-D</p> <p>AUDI CON TERMOSTATO Audi A3 V6 3.2L 06/07 Audi A4 y A6 V6 3.2L 06/07, Audi TT V6 3.2L 04/06 VR6 6 Cil. No. Original: 06E121111D</p>	<p>111-K</p> <p>AUDI Nacional Audi A4 1.8L 4Cil 04/Up CON HOUSING No. Original: 06B121111K</p>
			
<p>122</p> <p>AUDI Nacional Audi A4 Avant (8D5, B5) 96/01, Audi A6 Avant (4B, C5) 97/05 4 Cil. Americana Audi A4 1.6 AHL 95/01, Audi A6 AJP, AQE, ARH, AWT 1.8 98/05, Passat 4 Motion AHL, ARM APV, ANA 1.6 97/02 No. Original: 06B 121 121</p>	<p>132-F</p> <p>AUDI Nacional Audi A4 (8d2, B5) 00/07 Passat (3B2) 00/07 4 Cil. Americana Passat AUG 1.8 98/01, Audi A4 AWT 1.8 98/01, Audi A6 APV, AEB, AWT 1.8 98/01 No. Original: 058 121 132A</p>	<p>133-A</p> <p>AUDI Nacional y Americana Audi 80 84/86, Audi Coupe 1.8L 4 Cil. 84/88 No. Original: 027121133 027121133A</p>	<p>133-BC</p> <p>AUDI Nacional Audi 1.8L 4Cil -/02 (Base corta 8 cm) No. Original: 06B121133D</p>

133-BL



AUDI

Nacional

Audi 1.8L 4 Cil 03/Up
(Base larga 9 cm)

No. Original: 06B121133D

133-E



AUDI

Nacional

Audi A4 95/00, A4 Avant 96/01, A6 97/05
Passat 96/00, 4 Cil.

Americana

Audi 200 ANZ 1.8 96/99

No. Original: 058 121 133B

145-B



AUDI

Nacional

Audi 80 90/91

Audi 80 (8C, B4) 91/94

Passat (3B6) 00/05 4 Cil.

Americana

Audi, Cabrio 2.0 A6, ABK 92/00

No. Original: 048 121 145B

CARTEK[®]

















AUTOPARTES

DEPOSITOS DE ANTICONGELANTE



DEPOSITOS DE ANTICONGELANTE



<p>595575</p> 	<p>6258AC</p> 	<p>8027AC</p> 	<p>2602AA</p> 
<p>CHRYSLER Depósito Anticongelante con tapón Stratus y Cirrus 2.4L 4 Cil. 95/00. No. Original: 04595575</p>	<p>CHRYSLER Depósito Anticongelante con tapón Stratus y Cirrus 2.0 y 2.4L 4 Cil. 01/Up No. Original: 04596258AC</p>	<p>CHRYSLER Depósito Anticongelante con tapón Neón 2.0 4 Cil. 00/06 No. Original: 5278027AC</p>	<p>CHRYSLER Depósito Anticongelante Ram Pick Up 3.7, 4.7 y 5.7L 02/Up No. Original: 050 72602 AA</p>
<p>K218AA</p> 	<p>K218AA-T</p> 	<p>K218AG</p> 	<p>K218AG-T</p> 
<p>FORD K218AA Depósito anticongelante KA 1.6 4 Cil. todos No. Original: M98KU 8K218AA</p>	<p>FORD Depósito CON TAPON</p>	<p>FORD Depósito anticongelante Courier 1.6 4 Cil. 01/Up con aire No. Original: M96FB 8K218AG</p>	<p>FORD Depósito CON TAPON</p>
<p>8K218B</p> 	<p>8K218B-T</p> 	<p>K218BA</p> 	<p>K218BA-T</p> 
<p>FORD Depósito anticongelante Fiesta First 02/07 4 Cil. Fiesta Sedan (dos salidas) No. Original: 25658K218B ZM2S658K218AC</p>	<p>FORD Depósito CON TAPON</p>	<p>FORD Depósito anticongelante Fiesta, Ecosport 03/08 4 Cil. (una salida) No. Original: 25658K218BA</p>	<p>FORD Depósito CON TAPON</p>
<p>104120</p> 	<p>104120-T</p> 	<p>K218CB</p> 	<p>K218CB-T</p> 
<p>FORD Depósito anticongelante Focus USA 2.0 SPI 2.0 ZETEC 01/04 4 Cil. No. Original: N5S4Z8A080AA</p>	<p>FORD Depósito CON TAPON</p>	<p>FORD Depósito anticongelante Courier 1.6L 4 Cil. 02/08 sin aire No. Original: M96FB8K218CB</p>	<p>FORD Depósito CON TAPON</p>

DEPOSITOS DE ANTICONGELANTE



32

<p>FORD Depósito anticongelante Fiesta 1.3 Y 1.4L 4 CIL. 98/01 No. Original: 96FB8K218BG</p>	<p>FORD Depósito CON TAPON</p>	<p>FORD Depósito anticongelante Ranger Argentino 1.6L 4 Cil. 02/07 No. Original: M2L5Z-8A080AA</p>	<p>FORD Depósito CON TAPON</p>
<p>FORD Depósito anticongelante Excursion 5.4L, F250 SD, F350 SD, F450 SD Y F550 SD 6.7L 8 Cil. 98/05 (acordeón) No. Original: M2C3Z-8A080AA</p>	<p>FORD Depósito CON TAPON</p>	<p>FORD Depósito doble. Anticongelante y limpiaparabrisas Ranger 2.4L 4 Cil. 04/07 No. Original: M7L5517C617CA</p>	<p>FORD Depósito CON TAPON</p>
<p>FORD 28A080 Depósito Anticongelante Windstar 3.8L 6 Cil. 95/05 No. Original: MXF2Z-8A080AA</p>	<p>FORD Depósito CON TAPON</p>	<p>FORD Depósito Anticongelante Ford Fiesta 4 Cil. 1.8L 11/12 No. Original: BE8Z8A080A</p>	<p>FORD Depósito CON TAPON</p>
<p>FORD Depósito Anticongelante con tapón Escape 3.0L 6 Cil. 00/03 con sensor No. Original: M1L8Z8A080BB</p>	<p>FORD Depósito Anticongelante con tapón Escape 3.0L 6 Cil. 00/03 con sensor No. Original: M1L8Z8A080BB</p>	<p>HYUNDAI 6900AA Depósito anticongelante Hyundai Atos 4.0 Cil. 1.0L 01/10 No. Original: 05069900AA</p>	<p>GENERAL MOTORS Depósito anticongelante Cavalier y Pontiac Sunfire 95/05, Malibú 97/04 2.2 y 2.4 Grand Am 99/05 2.4 No. Original: 22712361</p>

DEPOSITOS DE ANTICONGELANTE



<p>712361-T</p>	<p>4150AM</p>	<p>4150AM-T</p>	<p>367722</p>
<p>GENERAL MOTORS Depósito CON TAPON</p>	<p>GENERAL MOTORS Depósito anticongelante Chevy 1.6L 94/04 No. Original: 301114150AM</p>	<p>GENERAL MOTORS Depósito CON TAPON</p>	<p>GENERAL MOTORS Depósito anticongelante Corsa y Tornado 1.8L 4 Cil. 06/08 CON AIRE ACONDICIONADO No. Original: 93367722</p>
<p>367722-T</p>	<p>367723</p>	<p>367723-T</p>	<p>562624</p>
<p>GENERAL MOTORS Depósito CON TAPON</p>	<p>GENERAL MOTORS Depósito anticongelante Corsa y Tornado 1.8L 4 Cil. 03/05 SIN AIRE ACONDICIONADO No. Original: 93367723</p>	<p>GENERAL MOTORS Depósito CON TAPON</p>	<p>GENERAL MOTORS Depósito anticongelante Matiz G1 y Spark 1.0L 4 Cil. 03/05 No. original: 96562624</p>
<p>562624-T</p>	<p>591467</p>	<p>591467-T</p>	<p>813425</p>
<p>GENERAL MOTORS Depósito CON TAPON</p>	<p>GENERAL MOTORS Depósito anticongelante Matiz G2 y Spark 1.0L 4 Cil. 06/10 No. original: 96591467</p>	<p>GENERAL MOTORS Depósito CON TAPON</p>	<p>GENERAL MOTORS Depósito Anticongelante Optra 4 Cil. 2.0L 07/11 No. Original: 96813425</p>
<p>813425-T</p>	<p>797286</p>	<p>797286-T</p>	<p>000QAA</p>
<p>GENERAL MOTORS Depósito CON TAPON</p>	<p>GENERAL MOTORS Depósito anticongelante Tahoe, Yukon, Avalanche, Suburban, Silverado 1500, 2500, Escalade, Sierra 4.3Lm 4.8L, 5.3L y 6.0L 07/11 No. Original: 22797286</p>	<p>GENERAL MOTORS Depósito CON TAPON</p>	<p>GENERAL MOTORS Depósito anticongelante Nissan Platina 1.6L 4 Cil. Todos No. Original.: 21710-00QAA</p>

DEPOSITOS DE ANTICONGELANTE















34

<p>000QAA-T</p>  <p>GENERAL MOTORS Depósito CON TAPON</p>	<p>21710</p>  <p>GENERAL MOTORS Depósito anticongelante con tapón NissanTsuru III 92/09 Sentra 96/00 y Tsubame todos 1.6L 4 Cil. No. Original:21710-F4300</p>	<p>F4020</p>  <p>NISSAN Depósito anticongelante con tapón Nissan D21 2.4L 4 Cil. 98/Up No.Original: 21710-F4020</p>	<p>71001</p>  <p>NISSAN Depósito anticongelante con tapón Urvan 00/10 2.5L 4 Cil No.Original: 21710-VW010</p>
<p>71020</p>  <p>NISSAN Depósito anticongelante D22 08/12 4 Cil. 2.4L No. Original: 21710-VN20A</p>	<p>10610</p>  <p>NISSAN Depósito anticongelante Sentra B15 01/06 4 Cil. 1.8 y 2.0L No. Original: 21710-6M100</p>	<p>17107</p>  <p>NISSAN Depósito anticongelante Urban 08/12 4 Cil. 2.4L No. Original: 21710-VZ70B</p>	<p>75121</p>  <p>TOYOTA Depósito anticongelante Toyota Hiace 05/11 4 Cil. 2.4L No. Original: 1647075121</p>
<p>121403</p>  <p>VOLKSWAGEN Depósito anticongelante Combi 1800 1.8L enfriada por aire superior No. Original: 025121403B</p>	<p>121403-T</p>  <p>VOLKSWAGEN Depósito CON TAPON</p>	<p>21407E</p>  <p>VOLKSWAGEN Depósito anticongelante Pointer A1 97/99 1.8L 4 Cil. No. Original: 171121407E</p>	<p>21407E-T</p>  <p>VOLKSWAGEN Depósito CON TAPON</p>
<p>21403L</p>  <p>VOLKSWAGEN Depósito anticongelante Passat 96/02 2.8L V-6 No. Original: 8D0121403L</p>	<p>21403L-T</p>  <p>VOLKSWAGEN Depósito CON TAPON</p>	<p>21407K</p>  <p>VOLKSWAGEN Depósito anticongelante Bora, Golf GTI 05/09 1.8L 4 Cil. No. Original: 1K0121407A</p>	<p>21407K-T</p>  <p>VOLKSWAGEN Depósito CON TAPON</p>

DEPOSITOS DE ANTICONGELANTE



<p>121407</p> 	<p>121407-T</p> 	<p>21403B</p> 	<p>21403B-T</p> 
<p>VOLKSWAGEN Depósito anticongelante Polo, Córdoba, Ibiza 1.6L 4 Cil. 97/04 No. Original: 6Q0121407</p>	<p>VOLKSWAGEN Depósito CON TAPON</p>	<p>VOLKSWAGEN Depósito anticongelante Golf y Jetta A4 99/06 Audi A3 97/03 2.0L 4 Cil. Seat León 01/06 No. Original: 1J0121403B</p>	<p>VOLKSWAGEN Depósito CON TAPON</p>
<p>21407A</p> 	<p>21407A-T</p> 	<p>21407C</p> 	<p>21407C-T</p> 
<p>VOLKSWAGEN Depósito anticongelante Golf y Jetta A2-A3 88/96 Pointer 1.8L 4 Cil. No. Original: 1H0121407A</p>	<p>VOLKSWAGEN Depósito CON TAPON</p>	<p>VOLKSWAGEN Depósito anticongelante Eurovan T4 2.5L 00/04 No. Original: 701121407C</p>	<p>VOLKSWAGEN Depósito CON TAPON</p>
<p>512140</p> 	<p>512140-T</p> 	<p>521407</p> 	<p>521407-T</p> 
<p>VOLKSWAGEN Depósito anticongelante T2A inferior Combi 1800 1.8L enfriada por aire inferior No. Original: 025121403</p>	<p>VOLKSWAGEN Depósito CON TAPON</p>	<p>VOLKSWAGEN Depósito anticongelante Lupo, Cros Fox 03/08 4 Cil. 1.6L No. Original: 5Z0-121-407</p>	<p>VOLKSWAGEN Depósito CON TAPON</p>

<p>TF107</p>  <p>FORD/MERCURY Máquina 171 V6 2.8L 74/79</p>	<p>TF117</p>  <p>FORD Topaz, Tempo, Ranger, Courier 140 2.3L 4L 74/78 s/AA</p>	<p>TF118</p>  <p>FORD Tunderbird, Cougar, Micro, Econoline V8 4.2L, 5.8L 75/94</p>	<p>TF123</p>  <p>FORD Máquina 351, 400 V8 77/79</p>	<p>TF136</p>  <p>FORD F100, F350, Econoline, Pick Up 460 7.5L 8cil 80/90</p>
<p>TF152</p>  <p>FORD Máquina 140 4cil 78/85</p>	<p>TF166</p>  <p>FORD Máquina 400 V8 80/83</p>	<p>TF168</p>  <p>FORD F100, F300, F350 6cil 80/84</p>	<p>TF215</p>  <p>FORD Maquina 426, 460 V8 68/79</p>	<p>TF217</p>  <p>FORD Topaz 4 cil 85/89</p>
<p>TF220</p>  <p>FORD Bronco II, Ranger 2.8L 6cil 83/85 Frontal</p>	<p>TF223</p>  <p>FORD Bronco II, Ranger Aerostar, F100/350 2.0L, 2.3L 4/6cil 83/87</p>	<p>TF258</p>  <p>FORD F100, F350 8 cil 85/90</p>	<p>TF261</p>  <p>FORD Bronco II, Ranger 6cil 2.9L 86/92</p>	<p>TF262</p>  <p>FORD F250/350, Van, Pick Up V8 86/87</p>
<p>TF263</p>  <p>FORD Topaz, Taurus 3.0L 86/94</p>	<p>TF264</p>  <p>FORD Taurus, Sable, Aerostar 3.0L 3.8L Máquina 230 86/93</p>	<p>TF268</p>  <p>FORD Bronco, E150, Econoline, F100 4.9L 6cil 86/92</p>	<p>TF269</p>  <p>FORD Topaz, Ghia 4cil 2.3L 90/94</p>	<p>TF270</p>  <p>FORD F150/350, Econoline, Pick Up 6/8cil 97/05</p>
<p>TF271</p>  <p>FORD Cougar, Topaz, Thunderbird L4 V6 2.3L, 3.8L 92/94</p>	<p>TF272</p>  <p>FORD Escort ZX2 L4 1.9L, 2.0L 98/03</p>	<p>TF273</p>  <p>FORD Contour, Cougar, Focus, Mystique L4 2.0L Dohc 01/04</p>	<p>TF274H</p>  <p>FORD Fiesta, Ikon, Ka L4 1.6L 03/08</p>	<p>TF274HT</p>  <p>FORD Fiesta, Ikon, Ka L4 1.6L 03/08</p>
<p>TF274 KIT</p>  <p>FORD Fiesta, Ikon, Ka L4 1.6L 03/08</p>	<p>TF275H</p>  <p>FORD Courier L4 1.6L 03/08</p>	<p>TF275HT</p>  <p>FORD Courier L4 1.6L 03/06</p>	<p>TF275 KIT</p>  <p>FORD Courier L4 1.6L 03/08</p>	<p>TF279</p>  <p>FORD Ranger V6 3.0L 91/95</p>



4 IMÁGENES

<p>CTF280</p>  <p>FORD Escape, Focus, Tribute, ZX3 L4 2.0L 16v 00/04</p>	<p>TF280 KIT</p>  <p>FORD Escape, Focus, Tribute, ZX4 L4 2.0L 16v 00/04</p>	<p>TF281</p>  <p>FORD Ranger V6 3.0L 95/97</p>	<p>TF282</p>  <p>FORD Explorer, Ranger V6 4.0L 90/00</p>	<p>TF284</p>  <p>FORD Windstar V6 3.8L 03/07</p>
<p>TF285</p>  <p>FORD Ecosport, Focus, Mondeo, Ranger L4 2.0L 01/06</p>	<p>TF286</p>  <p>FORD Ecosport, Escape, Focus, Fusion Ranger, L4 2.0L 07/08</p>	<p>T286F KIT</p>  <p>FORD Ecosport, Escape, Focus, Fusion Ranger, L4 2.0L 07/09</p>	<p>TF290</p>  <p>FORD/MERCURY Explorer, Mountaineer, Ranger V6 4.0L, 4.6L 89/04</p>	<p>TF290 KIT</p>  <p>FORD/MERCURY Explorer, Mountaineer, Ranger V6 4.0L 4.6L 89/05</p>
<p>TF291</p>  <p>FORD Grand Marquis V8 4.6L 96/99</p>	<p>TF292</p>  <p>FORD Escort I4 1.6L 16v 81/85</p>	<p>TF293</p>  <p>FORD/MERCURY Explorer, Mountaineer, Ranger V6 4.0L 97/04</p>	<p>TF294</p>  <p>FORD Explorer, Ranger V6 4.0L 97/01</p>	<p>TF301</p>  <p>FORD Cotour V6 2.5L 98/00</p>
<p>TF302</p>  <p>FORD Marquis V8 4.6L 98/03</p>	<p>TF303</p>  <p>FORD Aerostar V6 3.0L 96/04</p>	<p>TG083</p>  <p>G.M. Suburban V8 4.1L 66/67</p>	<p>TG099</p>  <p>G.M. Montecarlo V6 2.8L 76/90</p>	<p>TG133</p>  <p>G.M. Suburban V8 4.1L 78/79</p>
<p>TG155</p>  <p>G.M. Chevette L4 1.6L 79/81</p>	<p>TG191</p>  <p>G.M. Century V6 2.8L 82/86</p>	<p>TG199</p>  <p>G.M. Blazer V8 5.0L 89/90</p>	<p>TG209</p>  <p>G.M. Suburban V8 6.2L Diesel 96/98</p>	<p>TG233</p>  <p>G.M. S10 L4 2.2L 95/03</p>
<p>TG236</p>  <p>G.M. Cutlass V6 3.1L 90/93</p>	<p>TG238</p>  <p>G.M. Silverado V8 5.7L 89/91</p>	<p>TG242</p>  <p>G.M. S10 V6 2.8L 86/91</p>	<p>TG246</p>  <p>G.M. Cavaller V6 3.1L 92/95</p>	<p>TG250</p>  <p>G.M. Lumina V6 3.8L 90/93</p>

IMÁGENES

 <p>TG251</p> <p>G.M. Pick Up V8 5.7L 73/78</p>	 <p>TG255</p> <p>G.M. Chevy, Meriva, Monza, Tornado L4 1.6L, 1.8L 02/08</p>	 <p>TG255T</p> <p>G.M. Chevy, Meriva, Monza, Tornado L4 1.6L, 1.8L 02/08</p>	 <p>TG257</p> <p>G.M./PONTIAC Cavalier, Sunfire L4 2.2L 95/04</p>	 <p>TG260T</p> <p>G.M./CADILLAC Silverado, Tahoe, Yukon V8 5.3L, 5.7L, 6.0L 97/08</p>
 <p>TG262</p> <p>G.M. Alero, Gran AM, Cavalier, Malibu Sunfire, L4 2.4L 96/00</p>	 <p>TG263</p> <p>G.M./PONTIAC Cavalier, Sunfire L4 2.2L 95/05</p>	 <p>TG264</p> <p>G.M. Cavalier L4 2.2L 97/98</p>	 <p>TG265</p> <p>G.M. Sonoma L4 2.2L 98/03</p>	 <p>TG266</p> <p>G.M. Uplander V6 3.1L 05/09</p>
 <p>TG267</p> <p>G.M. Astro V6 4.3L 90/94</p>	 <p>TG268</p> <p>G.M. Express Van V6 4.3L 97/04</p>	 <p>TG269</p> <p>G.M. Suburban V8 5.7L 96/00</p>	 <p>TG276</p> <p>G.M. Astra, Vectra L4 2.2L, 2.4L 16v 04/06</p>	 <p>TG278</p> <p>G.M. Aveo, LS, LT L4 1.6L 05/07</p>
 <p>TG284</p> <p>G.M. Jimmy V6 4.3L 85/94</p>	 <p>TG705</p> <p>G.M. Suburban V8 6.0L 00/01</p>	 <p>TG719</p> <p>G.M. Astra, Corsa, Meriva, Tornado L4 1.4L, 1.8L 02/08</p>	 <p>TH259</p> <p>ACURA/HONDA TSX, Accord L4 2.4L 03/09</p>	 <p>TH501</p> <p>HYUNDAI Atos, Accent L4 1.0L, 1.1L, 1.5L, 1.6L 01/04</p>
 <p>TH502</p> <p>HYUNDAI Atos, Accent L4 1.0L, 1.1L, 1.5L, 1.6L 01/05</p>	 <p>TH503</p> <p>HYUNDAI Atos, Accent L4 1.0L, 1.1L, 1.5L, 1.6L 01/06</p>	 <p>TH504</p> <p>HYUNDAI Atos L4 1.0L, 1.1L 05/08</p>	 <p>TH505</p> <p>HYUNDAI Atos L4 1.0L, 1.1L 05/08</p>	 <p>TH506</p> <p>HYUNDAI Atos L4 1.0L, 1.1L 05/08</p>
 <p>TN179</p> <p>NISSAN/RENAULT Platina, Clio L4 1.6L 16v 02/09</p>	 <p>TN203</p> <p>NISSAN 200SX L4 2.0L 74/82</p>	 <p>TN207</p> <p>NISSAN 200SX L4 2.2L 80/83</p>	 <p>TN250</p> <p>NISSAN Tsuru I, II, III L4 1.6L 84/92</p>	 <p>TN307</p> <p>NISSAN Sentra L4 1.8L 16v 92/94</p>



Anticongelante
Refrigerante

CARTEK
AUTOPARTES

6 IMÁGENES

<p>TN308</p>  <p>NISSAN D21 L4 2.4L 94/04</p>	<p>TN309</p>  <p>NISSAN 240Z L4 2.0L, 2.4L 80/88</p>	<p>TN310</p>  <p>NISSAN Z24 L4 2.0L, 2.4L 80788</p>	<p>TN311</p>  <p>NISSAN Motor J L4 1.5L 1.6L 68/88</p>	<p>TN312</p>  <p>NISSAN Tsuru I, II, III L4 1.6L 94/01</p>
<p>TN314</p>  <p>NISSAN Tsubame L4 1.8L 93/98</p>	<p>TN315</p>  <p>NISSAN Tsuru III L4 1.8L 16v 93/06</p>	<p>TN316</p>  <p>NISSAN Urvan L4 2.4L 99/01</p>	<p>TN318</p>  <p>NISSAN Tsuru III L4 1.8L 94/99</p>	<p>TN319</p>  <p>NISSAN Urvan L4 2.4L 02/08</p>
<p>TN320BT</p>  <p>NISSAN Altima, Maxima, Murano, Quest V6 3.5L 02/07</p>	<p>TP001</p>  <p>PEUGEOT 406 V6 3.0L 00/04</p>	<p>TR402</p>  <p>RENAULT Clio, Megane, Scenic L4 2.0L 04/05</p>	<p>TT145</p>  <p>TOYOTA Hilux L4 2.0L, 2.2L 84/90</p>	<p>TT175</p>  <p>TOYOTA Celica L4 2.2L 77/79</p>
<p>TT289</p>  <p>TOYOTA Supra V6 2.8L 82/88</p>	<p>TT293</p>  <p>TOYOTA Corolla L4 1.6L 83/88</p>	<p>TT306</p>  <p>TOYOTA Vans 2.0L, 2.2L 84/90</p>	<p>TV049</p>  <p>VOLKSWAGEN Caribe L4 1.6L 80/84</p>	<p>TV087A</p>  <p>VOLKSWAGEN Golf, Jetta A4 L4 2.0L 99/06</p>
<p>TV087B</p>  <p>VOLKSWAGEN Golf, Jetta A4 L4 2.0L 99/06</p>	<p>TV087C</p>  <p>VOLKSWAGEN Golf, Jetta A5 L4 2.0L 99/06</p>	<p>TV087LG</p>  <p>VOLKSWAGEN Bora L5 2.5L 05/10</p>	<p>TV111B</p>  <p>VOLKSWAGEN Lupo L4 1.6L 07/10</p>	<p>TV111N</p>  <p>VOLKSWAGEN Polo L4 1.6L 04/05</p>
<p>TV117A</p>  <p>VOLKSWAGEN VR6 V6 2.8L 92/95</p>	<p>TV117C</p>  <p>VOLKSWAGEN Golf, Jetta L4 1.8L 87/94</p>	<p>TV117D</p>  <p>VOLKSWAGEN Golf, Jetta L4 1.8L 83/92</p>	<p>TV117M</p>  <p>VOLKSWAGEN Golf, Jetta L4 1.8L 91/94</p>	<p>TV117N</p>  <p>SEAT Cordova, Ibiza L4 1.4L, 1.6L 00/02</p>

<p>TV117V</p>  <p>SEAT Cordova, Ibiza L4 1.4L, 1.6L 00/02</p>	<p>TV118D</p>  <p>VOLKSWAGEN Polo L4 1.6L 02/08</p>	<p>TV120</p>  <p>VOLKSWAGEN Derby, Golf, Jetta A3 L4 1.8L 93/98</p>	<p>TV121</p>  <p>VOLKSWAGEN Beetle, Golf, Jetta A4 L4 2.0L 99/06</p>	<p>TV121A</p>  <p>VOLKSWAGEN Eurovan, Golf, Jetta A3, Passat V6 2.8L 95/98</p>
<p>TV121B</p>  <p>VOLKSWAGEN Pointer L4 1.8L 98/04</p>	<p>TV121C</p>  <p>VOLKSWAGEN Beetle, Golf, Jetta A4, Passat, Polo L4 2.0L 00/06</p>	<p>TV121D</p>  <p>AUDI/VOLKSWAGEN A3, A4 Quattro, Passat L4 1.8L 97/01</p>	<p>TV121F</p>  <p>VOLKSWAGEN Derby, Golf, Jetta, Rabbit L4 1.8L 79/98</p>	<p>TV121G</p>  <p>VOLKSWAGEN Eurovan L5 2.5L 91/03</p>
<p>TV121H</p>  <p>VOLKSWAGEN Polo L4 1.6L 02/04</p>	<p>TV121J</p>  <p>VOLKSWAGEN Golf, Jetta A4, Polo L4 2.0L 99/05</p>	<p>TV121K</p>  <p>SEAT Ibiza L4 1.4L 02/08</p>	<p>TV122</p>  <p>AUDI/VOLKSWAGEN A4, Passat L4 1.8L 97/05</p>	<p>TV131</p>  <p>VOLKSWAGEN Eurovan, Golf, Jetta, Passat, Pointer L4 1.8L 88/90</p>
<p>TV132</p>  <p>SEAT/VOLKSWAGEN León, Toledo, Golf, Jetta A4 L4 2.0L 99/04</p>	<p>TV132B</p>  <p>VOLKSWAGEN Caravelle, Corsa, Rabbit L4 1.8L 84/93</p>	<p>TV132C</p>  <p>SEAT/VOLKSWAGEN Bora, Jetta, León, Polo L 1.9L 2.0L 01/06</p>	<p>TV132D</p>  <p>SEAT/VOLKSWAGEN Jetta A4, León, Toledo L4 1.9L Turbo 98/09</p>	<p>TV132E</p>  <p>VOLKSWAGEN Eurovan L5 2.5L 04/07</p>
<p>TV132F</p>  <p>AUDI/VOLKSWAGEN A4, Passat L4 1.8L 00/07</p>	<p>TV132H</p>  <p>VOLKSWAGEN Polo, Lupo L4 1.6L, 98/05</p>	<p>TV132I</p>  <p>VOLKSWAGEN Eurovan L5 2.5L 03/06</p>	<p>TV132J</p>  <p>SEAT/VOLKSWAGEN Beetle, Cordova, Golf, Ibiza L4 1.9L 2.0L 01/06</p>	<p>TV132V</p>  <p>SEAT Ibiza L4 1.4L 02/03</p>
<p>TV133</p>  <p>VOLKSWAGEN Caribe L4 1.6L 80/84</p>	<p>TV1331</p>  <p>VOLKSWAGEN Derby, Derby Van, Pointer L4 1.8L 01/06</p>	<p>TV133AB</p>  <p>VOLKSWAGEN Golf, Jetta L4 2.8L 88/90</p>	<p>TV133B</p>  <p>VOLKSWAGEN Golf, Jetta L4 1.8L 88/90</p>	<p>TV133C</p>  <p>VOLKSWAGEN Passat L4 2.0L 93/98</p>

8 IMÁGENES

<p>TA050</p> <p>AUDI/SEAT</p>	<p>TA077</p> <p>VAM Gremlin, Lerma, Rambler V6 3.8L, 4.2L 63/83</p>	<p>TV121D</p> <p>AUDI/VOLKSWAGEN A3, A4 Quattro, Passat L4 1.8L 97/01</p>	<p>TV122</p> <p>AUDI/VOLKSWAGEN A4, Passat L4 1.8L 97/05</p>	<p>TV132F</p> <p>AUDI/VOLKSWAGEN A4, Passat L4 1.8L 00/07</p>
<p>TV145B</p> <p>AUDI/VOLKSWAGEN 80, Cabrio, Passat L4 2.0L 90/00</p>	<p>TC013</p> <p>DODGE Ram V8 5.2L, 5.9L, D600 81/93</p>	<p>TC023</p> <p>CHRYSLER/DODGE Dart, Lebaron, Town & Country V6 3.2L, 3.7L 60/87</p>	<p>TC153</p> <p>CHRYSLER/DODGE Lebaron, N/Yorker, Town & Country V8 V6 5.2L, 5.9L, 3.9L 79/91</p>	<p>TC169</p> <p>CHRYSLER/DODGE Phantom, Shadow, Spirit, Neon L4 2.0L, 2.2L, 2.5L 82/95</p>
<p>TC172</p> <p>CHRYSLER/DODGE Voyager, Caravan, Plymouth V6 3.0L 96/00</p>	<p>TC173</p> <p>CHRYSLER/DODGE Town&Country, Caravan, Voyager V6 3.3L, 3.8L 90/92</p>	<p>TC174</p> <p>CHRYSLER Shadow, Spirit, Voyager, T&Country 4L 2.5L, 3.3L 91/94</p>	<p>TC175</p> <p>CHRYSLER/DODGE Durango, Dakota, Ram, Pick Up V6 V8 3.9L, 5.2L, 5.9L 92/02</p>	<p>TC176</p> <p>CHRYSLER Grand Voyager, Town & Country 3.3L, 3.8L V6 99/00</p>
<p>TC177</p> <p>CHRYSLER Dakota, Jeep Cherokee, G/Cherokee 4/6L 2.5L, 4L 93/04</p>	<p>TC179</p> <p>CHRYSLER/DODGE Ram 2500, 3500, Pick Up 5.9L 00/UP</p>	<p>TC179V</p> <p>CHRYSLER Jeep Cherokee, Wagoneer, Jeep CJ V8 5.0L, 5.9L 80/94</p>	<p>TC181</p> <p>CHRYSLER Neon L4 2.0L 00/06</p>	<p>TC182</p> <p>DODGE Breeze, Cirrus, Sebring, Stratus L4 2.4L 95/06</p>
<p>TC183</p> <p>CHRYSLER Neon L4 2.0L Dohc 95/99</p>	<p>TC184</p> <p>CHRYSLER Stratus L4 2.4L Turbo 96/02</p>	<p>TC186</p> <p>CHRYSLER PT Cruiser L4 2.4L 00/09</p>	<p>TC190</p> <p>CHRYSLER/Jeep Cherokee, Dakota, Durango, Ram Pick up, V6 3.9L 00/03</p>	<p>TF008</p> <p>FORD Topaz 4L 2.3L 84/UP</p>
<p>TF051</p> <p>FORD Series E,F, Econoline, Van, Pick Up Máquina 300 73/78</p>	<p>TF074</p> <p>FORD F100, F350 V8 Máquina 360, 390 6.4L 66/76</p>	<p>TF079</p> <p>FORD F100, F150, F200, F250, F350, F600 V8 Autos y Camiones c/entrada</p>	<p>TF081</p> <p>FORD/MERCURY Falcon, F100 6L Máquina 250 4.1L 68/94</p>	<p>TF089</p> <p>FORD F100, F150, F200, F250, F350, F600 V8 Autos y Camiones s/entrada</p>

IMÁGENES

<p>TV133D</p>  <p>VOLKSWAGEN Golf, Jetta L4 1.8L 93/98</p>	<p>TV133E</p>  <p>VOLKSWAGEN A4, Passat L4 1.8L 94/99</p>	<p>TV133E/F</p>  <p>VOLKSWAGEN Golf, Jetta L4 1.8L 88/92</p>	<p>TV133EN</p>  <p>VOLKSWAGEN Golf, Jetta L4 1.8L 88/93</p>	<p>TV133G</p>  <p>VOLKSWAGEN A3, Beetle, Cabrio, Golf, Jetta A4, TT L4 1.8L Turbo 99/05</p>
<p>TV143D</p>  <p>VOLKSWAGEN Eurovan L5 2.5L 93/96</p>	<p>TV144</p>  <p>VOLKSWAGEN Derby, Golf, Jetta, Pointer L4 1.8L 93/98</p>	<p>TV44B</p>  <p>VOLKSWAGEN Golf, Jetta L4 1.8L 87/99</p>	<p>TV144C</p>  <p>VOLKSWAGEN Bora, Eurovan, Jetta L4 1.9L 05/06</p>	<p>TV144H</p>  <p>VOLKSWAGEN Derby, Golf, Jetta L4 2.0L 93/98</p>
<p>TV144J</p>  <p>VOLKSWAGEN Golf, Jetta L4 2.0L 93/98</p>	<p>TV145</p>  <p>VOLKSWAGEN Atlantic L4 1.8L 85/86</p>	<p>TV1452</p>  <p>VOLKSWAGEN Pointer L4 1.8L 04/08</p>	<p>TV1452A</p>  <p>VOLKSWAGEN Pointer L4 1.8L 04/08</p>	<p>TV145C</p>  <p>VOLKSWAGEN Golf, Jetta L4 1.8L 88/93</p>
<p>TV145B</p>  <p>AUDI/VOLKSWAGEN 80, Cabrio, Passat L4 2.0L 90/00</p>	<p>TV145P</p>  <p>VOLKSWAGEN Golf, Jetta L4 1.8L 84/93</p>	<p>TV291AD</p>  <p>SEAT/VOLKSWAGEN Beetle, Jetta A4, León L4 1.8L turbo</p>	<p>TV291B</p>  <p>VOLKSWAGEN Jetta A4, Beetle L4 2.0L 99/06</p>	<p>TV291D</p>  <p>VOLKSWAGEN Beetle L4 1.8L Turbo</p>
<p>TV291E</p>  <p>VOLKSWAGEN Bora L5 2.5L 05/09</p>	<p>TV291F</p>  <p>VOLKSWAGEN A4, Beetle L4 1.8L 99/06</p>	<p>TV619</p>  <p>VOLKSWAGEN Cabriolet, Derby, Golf, Jetta, Polo L4 1.8L 99/06</p>		



CARTEK[®]

AUTOPARTES

 Like en
Facebook

facebook.com/cartek.autopartes



Venta directa en México contactar:

01 800 627 2044 Guadalajara, Jal.

01 800 711 6368 Morelia, Mich.

01 800 633 5455 Culiacán, Sin.

01 800 500 1020 León, Gto.

Distribuciones en Latinoamérica de productos

CARTEK contactar: (+52) 33 3837 5610

 www.cartek.com.mx



CARTEK
SERVICIO TÉCNICO



01800CARTEKS
018002278357